

MultiClamp 700B

**COMPUTER-CONTROLLED
MICROELECTRODE AMPLIFIER**

Theory and Operation

Part Number 2500-0157 Rev D March 2005 Printed in USA

Copyright 2005 Axon Instruments / Molecular Devices Corp.

No part of this manual may be reproduced, stored in a retrieval system, or transmitted, in any form or by any means, electronic, mechanical, photocopying, microfilming, recording, or otherwise, without written permission from Molecular Devices Corp.

QUESTIONS? See Axon's Knowledge Base: <http://support.axon.com>

PLEASE READ!!!! SAFETY

There are important safety issues that you must take into account when using this instrument. Please carefully read the safety warnings starting on page 159 before you use this instrument.

VERIFICATION

This instrument is extensively tested and thoroughly calibrated before leaving the factory. Nevertheless, researchers should independently verify the basic accuracy of the controls using resistor/capacitor models of their electrodes and cell membranes.

WARNING

If this equipment is used in a manner not specified by the manufacturer, the protection provided by the equipment may be impaired.

DISCLAIMER

This equipment is not intended to be used, and should not be used, in human experimentation or applied to humans in any way.

Table of Contents

| | |
|--|-----------|
| Chapter 1 Introduction | 1 |
| Chapter 2 Installation and Basic Operation | 3 |
| Installation..... | 3 |
| Check List | 3 |
| Installing Hardware..... | 4 |
| Installing the MultiClamp 700B Commander | 4 |
| Functional Checkout | 6 |
| Communication with the MultiClamp 700B..... | 6 |
| Setting Parameters in the MultiClamp 700B Commander..... | 7 |
| Toolbar Buttons in the MultiClamp 700B Commander..... | 9 |
| Test the Noise..... | 10 |
| Calibration..... | 11 |
| Getting Help in the MultiClamp 700B Commander | 13 |
| Chapter 3 Tutorials | 15 |
| Check List | 15 |
| Model Cell..... | 16 |
| Tutorial 1 – Electrode in the Bath: Voltage Clamp..... | 17 |
| Tutorial 2 – Electrode in the Bath: Current Clamp | 19 |
| Tutorial 3 – Giga Seal Configuration..... | 21 |
| Tutorial 4 – Whole-Cell Configuration: Voltage Clamp..... | 26 |
| Tutorial 5 – Whole-Cell Configuration: Current Clamp..... | 31 |
| Tutorial 6 – Whole-Cell Configuration: Automatic Mode Switching..... | 37 |

| | |
|---|-----------|
| Chapter 4 Guide to Electrophysiological Recording..... | 43 |
| General Advice..... | 44 |
| Chamber Design..... | 44 |
| Perfusion..... | 44 |
| Mechanical Stability..... | 44 |
| Optics..... | 45 |
| Bath Electrode..... | 45 |
| Interfacing a Computer..... | 46 |
| Computer Noise..... | 47 |
| Patch Clamping..... | 47 |
| Headstage and Holder Considerations..... | 47 |
| Forming a Gigaseal..... | 49 |
| Whole-cell Voltage Clamp Recording..... | 51 |
| Perforated-patch Recording..... | 54 |
| Low Noise Techniques..... | 55 |
| Sharp Microelectrode Recording..... | 59 |
| Sharp Microelectrode or Patch Electrode?..... | 60 |
| Microelectrode Properties..... | 60 |
| Filling Solutions..... | 64 |
| Impaling Cells..... | 64 |
| Chapter 5 Reference Section..... | 67 |
| Audio Monitor..... | 68 |
| Bath Headstage and Electrodes..... | 72 |
| R_b Minimization..... | 72 |
| Use of a Bath Headstage..... | 74 |
| Bridge Balance..... | 75 |
| Bridge Balance in the Bath..... | 76 |
| Bridge Balance in the Cell..... | 77 |
| Buzz..... | 78 |
| Capacitance Compensation..... | 78 |
| Electrode Capacitance Compensation..... | 79 |
| Whole-Cell Capacitance Compensation..... | 80 |

| | |
|---|-----|
| Auto Button | 83 |
| Manual Adjustment of Capacitance Compensation | 83 |
| Filtering the Command Stimulus | 84 |
| Capacitance Neutralization | 84 |
| Input Capacitance | 84 |
| Adjusting Capacitance Neutralization..... | 86 |
| Limitations of Capacitance Neutralization..... | 86 |
| Clear | 87 |
| Electrochemistry..... | 87 |
| External Command Inputs..... | 89 |
| External Command Sensitivity..... | 89 |
| Additivity of Commands..... | 90 |
| Command Filter Frequency..... | 90 |
| Feedback Resistor | 91 |
| V-Clamp Mode..... | 91 |
| I-Clamp Mode..... | 93 |
| Filters..... | 93 |
| -3 dB Frequency | 94 |
| Types of Filters | 95 |
| Bessel Filter..... | 95 |
| Butterworth Filter..... | 95 |
| Choosing the Cutoff Frequency | 95 |
| High-pass Filter | 97 |
| Command Filter Frequency..... | 97 |
| Grounding and Hum..... | 97 |
| Headstage | 98 |
| Voltage Clamp Circuit | 99 |
| Current Clamp Circuit..... | 101 |
| Mounting the Headstage..... | 102 |
| Bath Connection..... | 102 |
| Cleaning | 102 |
| Static Precautions | 102 |
| Acoustic Pick-up..... | 102 |

| | |
|---|-----|
| Help | 103 |
| Holders | 103 |
| Holder Design | 103 |
| Optional Ag/AgCl Pellets | 105 |
| Holder Use | 105 |
| Holder Maintenance | 107 |
| Adapters | 107 |
| Input/Output Connections | 107 |
| Front Panel | 107 |
| Rear Panel | 109 |
| Leak Subtraction | 110 |
| Mode | 111 |
| Model Cell | 112 |
| Noise | 113 |
| Noise | 114 |
| Measurement of Noise | 114 |
| Sources of Noise | 114 |
| Oscilloscope Triggering | 116 |
| Output Zero | 117 |
| Overload | 118 |
| Polarity Conventions | 118 |
| Biological Polarity Conventions | 118 |
| MultiClamp Polarity Conventions | 119 |
| Polarity Summary for Different Recording Configurations | 120 |
| Power Supply | 120 |
| Supply Voltage Selection | 121 |
| Changing the Fuse | 121 |
| Glitches | 121 |
| Select Device | 122 |
| Series Resistance Compensation | 122 |
| Introduction to R_s Compensation | 122 |
| Is R_s Compensation Necessary? | 124 |
| Adjusting R_s Compensation | 125 |

| | |
|---|------------|
| Theory of R_s Compensation | 129 |
| The ‘Prediction’ Control | 130 |
| The ‘Prediction’ Control | 131 |
| Saturation Effects | 132 |
| Readjustment of Whole Cell Compensation with ‘Prediction’ | 133 |
| The ‘Correction’ Control..... | 134 |
| Readjustment of Whole Cell Compensation with ‘Correction’ | 135 |
| Setting ‘Prediction’ and ‘Correction’ Values..... | 135 |
| Oscillations..... | 135 |
| Limitations of R_s Compensation | 136 |
| SoftPanel Configuration..... | 137 |
| Status..... | 138 |
| Zap..... | 138 |
| Chapter 6 Troubleshooting..... | 139 |
| Chapter 7 Specifications | 141 |
| References | 147 |
| Technical Assistance..... | 149 |
| Warranty and Repair Service | 151 |
| Declaration of Conformity..... | 157 |
| Important Safety Information..... | 159 |
| Index..... | 163 |

Chapter 1

Introduction

The MultiClamp 700B is a computer-controlled microelectrode current and voltage clamp amplifier for electrophysiology and electrochemistry. It is a versatile instrument capable of single-channel and whole-cell voltage patch clamping, high-speed current clamping (patch or sharp electrode), ion-selective electrode recording, amperometry / voltammetry and bilayer recording (optional headstage).

The MultiClamp 700B was designed to support one or two primary headstages (CV-7), in addition to two auxiliary headstages (optional HS- or VG-type, purchased separately). Each CV-7 headstage contains a current-to-voltage converter for voltage (patch) clamp and a voltage follower for current clamp. This allows the user to conveniently switch between low-noise patch-clamp recording and high-speed current-clamp recording. Also, an optional CV-7 headstage will allow bilayer recording.

The MultiClamp 700B is essentially an analog input / output instrument, similar to conventional amplifiers by Axon Instruments. Thus, BNC-type input and output connections are necessary to communicate with a digitizing interface, oscilloscope or other recording device. The MultiClamp 700B contains no front panel knobs and switches. Instead, the instrument is operated using a control panel program, the MultiClamp 700B Commander, which runs on a host computer and communicates with the amplifier via a USB cable.

Computer control permits “smart” automatic features, such as capacitance compensation, bridge balance and offsets. Telegraph information, performed through software messaging, includes Gain, Filter and Capacitance, as well as input/output Scaling Factors and recording Mode.

The MultiClamp 700B Commander interface is completely independent of acquisition software. Thus, the MultiClamp 700B can be used with any data acquisition package. It is, of course, compatible with the Digidata series (1200A or later) digitizers and pCLAMP 7 (or later) software. (**Note:** However, telegraphing is only supported in pCLAMP versions 9 and higher.) Regarding third-party software, see our webpage “Developer Info” for a detailed Software Development Kit that describes how to read telegraph information.

We recognize that software control of an amplifier is an unusual step forward for some users. If computer mouse control is unsettling, consider the optional *SoftPanel* device to control the MultiClamp 700B. The SoftPanel is essentially a hardware extension of the MultiClamp 700B Commander software. Knobs and buttons replace mouse or keyboard control. For more information, visit our website or call Axon Technical Support.

The MultiClamp 700B is a sophisticated instrument. Experienced and inexperienced researchers alike are advised to read this manual thoroughly and to familiarize themselves with the instrument. The ***Functional Checkout and Tutorials*** sections of the following chapter provide step-by-step instructions using the PATCH-1U model cell, which provides resistors and parallel RC circuits to mimic the pipette, patch and whole-cell recording conditions.

We will be pleased to answer any questions regarding the theory and use of the MultiClamp 700B. Any comments and suggestions on the use and design of the MultiClamp 700B will be much appreciated. We welcome reprints of papers describing work performed with the MultiClamp 700B. Keeping abreast of your research helps us to design our instruments for maximum usefulness.

Chapter 2

Installation and Basic Operation

Installation

Carefully unpack all parts, and use the enclosed shipping list to verify that all parts have been received. Retain packing materials in case the instrument needs to be returned to the factory at a later date.

For the initial checkout, the MultiClamp 700B should be situated on a bench top away from other equipment. Do not install it in a rack until the checkout is complete.

Check List

These installation and checkout procedures require the following:

1. MultiClamp 700B main unit with power cord.
2. CV-7 headstage(s) with PATCH-1U model cell(s).
3. USB (A/B-type) control cable.
4. MultiClamp 700B Commander host software (from CD or website).

5. A PC running Windows operating system (version 95 and NT not supported), or Mac OS 10.2 or higher with the display set to at least 800 x 600. The PC should have one spare USB port. In order to use on-line Help, the PC should have Internet access and a web browser with JavaScript (Internet Explorer v. 4 or later, or equivalent).
6. External oscilloscope.

Installing Hardware

1. Connect the appropriate end of the USB cable to the USB connector on the MultiClamp 700B rear panel, and the other end to a free USB port on your PC.
2. Connect the CV-7 headstage(s) to HEADSTAGE #1 and HEADSTAGE #2 rear panel connectors, respectively. THE AMPLIFIER SHOULD BE TURNED OFF WHENEVER HEADSTAGES ARE CONNECTED. Note a small white cap covering one of the headstage input pin sockets, and a corresponding missing pin on the headstage connector. This is normal.
3. Connect the power cable, and turn on the MultiClamp 700B. The front panel POWER light should illuminate, as well as the VOLTAGE CLAMP light for each channel. Windows operating system will automatically recognize the new USB hardware as a Human Interface Device (HID).
4. If you are using the optional SoftPanel device, connect it to a different computer USB port using the USB cable supplied with the SoftPanel.

Installing the MultiClamp 700B Commander

1. Run the MultiClamp 700B Commander installer from the enclosed CD, or from the installation file downloaded from the Axon website. This will install all necessary files and generate a shortcut for *MultiClamp 700B* on your desktop.

2. Run MultiClamp 700B Commander by double-clicking on the *MultiClamp 700B* desktop icon. The first time the program is run, you will be asked to update MultiClamp 700B Commander. If you've just installed the software from the CD, we suggest that you download the latest update. Axon Instruments is very responsive to customer feedback, thus the website will likely contain a newer, updated version. We also recommend that you choose to be reminded every 30 days to check for a new download.
3. Next you will see the Device Selection dialog. Select *MultiClamp Hardware*, then click the *Scan* button. The amplifier Serial Number will be identified in the list when the instrument is successfully recognized.

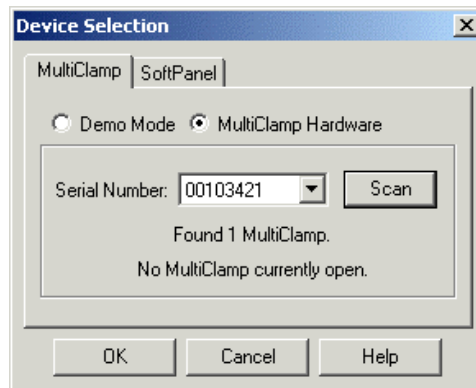



Figure 2.1

If the program is unable to find a valid Serial Number, check that the MultiClamp 700B is switched on and that the USB cable is connected properly.

4. If you are using the optional SoftPanel device, click on the SoftPanel tab and click the *Scan* button. After this device is recognized, click the OK button.
5. The main MultiClamp 700B Commander window should appear. If installed correctly, the MultiClamp Serial Number will appear in the 700B

Commander window heading. (And, if the optional SoftPanel is configured correctly, the Configure SoftPanel icon  will be colored.

Functional Checkout

The purpose of this section is to quickly check the correct operation of the MultiClamp 700B and to briefly describe the basic controls of the MultiClamp 700B Commander. This information, in addition to the extensive 700B Commander online Help, should enable you to work comfortably with the features of the amplifier. Finally, the following chapter *Tutorials* will guide you step-by-step through the various recording configurations.

Communication with the MultiClamp 700B

1. Check that the STATUS light on the front of the MultiClamp 700B is flashing. This indicates that the MultiClamp 700B Commander is polling the MultiClamp 700B, updating its meter displays.
2. Toggle the Channel 1 and Channel 2 Mode buttons, switching repeatedly between Voltage Clamp (VC) and Current Clamp (I=0, IC) modes:

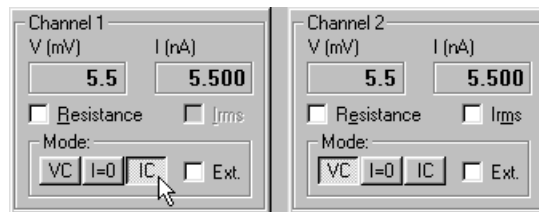



Figure 2.2

The tabs immediately below the mode switches will change appropriately. Also, the VOLTAGE CLAMP (blue) and CURRENT CLAMP (green) indicator lights on the front panel of the MultiClamp 700B should also confirm that the amplifier is changing modes.

Setting Parameters in the MultiClamp 700B Commander

Many parameter fields in the MultiClamp 700B Commander can be set in three different ways. To demonstrate this, press the V-Clamp 1 tab and try the following.

1. *Glider control*

- Position the cursor over the parameter field to the right of Holding, noting that the cursor changes to a vertical double-headed arrow (). Hold down the left mouse button and drag the mouse up and down; the holding potential changes in 1 mV steps.
- Press the Shift key while dragging the mouse; the holding potential changes in 5 mV steps.
- Press the Ctrl key while dragging the mouse; the holding potential changes in 20 mV steps.
- Position the cursor over the button with the black dot (dual control) to the right of Cp Fast, noting that the cursor changes to crossed double-headed arrows (). Holding down the left mouse button and dragging the mouse vertically changes the capacitance parameter (pF), while dragging horizontally changes the time constant parameter (τ_s). Simultaneously pressing the Shift or Ctrl key respectively magnifies the effect (however, in a non-linear manner for this particular control).

2. *Entering text directly*

- Position the cursor over the parameter field to the right of Holding and double click. Type a number, and then press Enter.



Figure 2.3

3. *Selecting from a list*

- Position the cursor over the frequency parameter to the right of Seal Test and press the right mouse button. A list of possible frequencies is displayed, one of which can be selected by a mouse click.

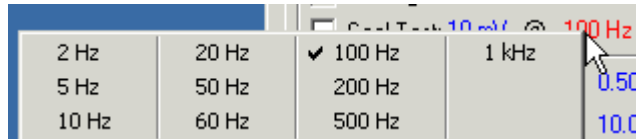

Figure 2.4

- Repeat for the Primary (or Secondary) Output field. In this case a right-click of the mouse will display a list of output signals.

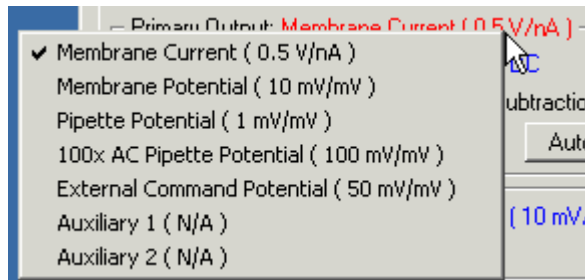

Figure 2.5

- Right-clicking the mouse over most other 700B Commander glider fields will display a menu to select the sensitivity of the glider. For example, right-click the mouse while over the Holding glider, and you will see the following menu.

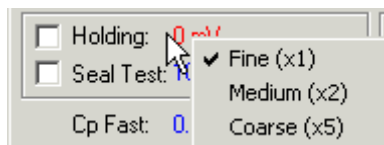

Figure 2.6

Toolbar Buttons in the MultiClamp 700B Commander

At the top of the MultiClamp 700B Commander main window is a row of toolbar buttons that provide access to a number of special features.

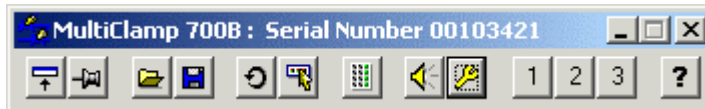



Figure 2.7

Positioning the mouse cursor over each button will, after a short delay, display a Tool Tip for the button. This Tool Tip will identify the alternative keyboard shortcut that will also activate the feature. For example, the "Resize Window" button is associated with the <F2> key. This feature will toggle the size of the Commander window between full-size, meters-only, or the user-adjusted size. Drag the lower-right corner of the Commander window to change the size, then click the <F2> key to toggle between window sizes.

Most other buttons are self-explanatory, with the possible exception of the Save Configuration (floppy disk icon), Load Configuration (folder icon) and Quick Select buttons (1, 2, 3). These buttons allow the user to store and retrieve parameter settings for the MultiClamp 700B Commander. The Quick Select buttons can be assigned to a particular set of parameter settings to facilitate rapid loading, or, alternatively, to run an executable command line. This might be useful for experiments that require different configurations, or when several users share the same recording setup, or when an external command is desired (for example, starting a custom script to initiate a software-controlled perfusion device).

Quick Select buttons are assigned as follows.

1. After setting the MultiClamp 700B Commander parameters to the desired values, press the Save Settings toolbar button. Enter a file name and directory (the file name is given the extension MCC, for MultiClamp 700B Commander file).

2. Press the Options toolbar button () and then press the Quick Select tab. Click in the name field for the Quick Select Button you wish to assign (1 through 3). Then use the Browse button to choose the name of the MCC file containing the desired parameter settings. (**Note:** if any executable file other than a MultiClamp configuration file is chosen for this button assignment, then that executable command will be run when this button is clicked.)
3. Back in the main MultiClamp 700B Commander panel, positioning the mouse over the assigned Quick Select button now displays the name of the assigned MCC file. Press the Quick Select button to load the parameter settings. Alternatively, the Load Configuration button () can be pressed to load any previously stored MCC file.

Test the Noise

All electronic equipment generates some amount of thermal noise. Follow these steps to measure the intrinsic MultiClamp 700B current noise (“Irms”, or the root-mean-square of the current noise):

1. Leave the CV-7 headstage in an “open circuit” configuration (*i.e.*, nothing should be attached to the input of the CV-7).
2. To reduce extraneous noise, the CV-7 must be shielded. This can be accomplished using aluminum foil, which should be *loosely* but *completely* wrapped around the headstage. A great alternative to foil shielding is a metal container, such as a coffee can. Most importantly, the input of the CV-7 should not make contact with the shield.
3. The shield must now be grounded to the CV-7. Connect the small, black grounding wire provided with your MultiClamp hardware to the gold, 1 mm input at the rear of the headstage case. Connect the other end of the ground wire to the foil or metal container using an “alligator” clip or other appropriate connection.

- In the MultiClamp 700B Commander, check the “Irms” box beneath the corresponding Channel meter for the CV-7 headstage (test one headstage at a time). Compare the value indicated by the meter to that listed in the table below (*5 kHz, 4-pole Butterworth measurement).

| Feedback Resistor | Noise* |
|-------------------|-------------|
| 50 M Ω | 2.0 pA rms |
| 500 M Ω | 0.8 pA rms |
| 5 G Ω | 0.5 pA rms |
| 50 G Ω | 0.15 pA rms |

- Repeat the Irms noise measure for each Feedback Resistor selected from the MultiClamp 700B Commander Options menu.
- If your MultiClamp has more than one CV-7 headstage, repeat steps 1-5 for the second headstage.

Calibration

The steps below provide a quick check of the calibration of the MultiClamp 700B. It is assumed that appropriate shielding (as described in “Test the Noise”, above) will be used during these tests.

- Connect an oscilloscope to the front panel PRIMARY or SCOPE Output BNC.
- Synchronize the oscilloscope by connecting to the rear panel SYNC OUTPUT BNC.

Press the “Reset to Program Defaults” button in the MultiClamp 700B Commander to standardize the MultiClamp 700B.

50 G Range

1. Press the “Options” button, choose the Gains tab, and select the 50 G feedback resistor in the Voltage Clamp pane. Return to the main MultiClamp 700B Commander window.
2. Plug the PATCH connector of the PATCH-1U model cell into the CV-7 headstage.
3. Set Seal Test amplitude to 100 mV and frequency to 50 Hz, then check the box to make it active.
4. Press Auto Cp Fast to remove the bulk of electrode capacitance transient.
5. The resulting waveform should be square, except for an initial overshoot (possibly twice the size of the steady-state response) that settles to the baseline in about 1 to 2 ms. The rise time to the peak of the overshoot should be about 50 μ s. The steady-state amplitude following the transient should be ~ 500 mV_{p-p} (± 50 mV).

5 G Range

1. Change the feedback resistor to 5 G in the Options / Gains menu.
2. Press Auto Cp Fast.
3. The step response should be ~ 50 mV_{p-p} (± 5 mV).

500 M Range

1. Press the “Reset to Program Defaults” button. (By default, the 500 M range is selected.)
2. Check Seal Test and set the amplitude to 25 mV.
3. Plug the CELL connector of the PATCH-1U model cell into the CV-7 headstage.
4. Press the Auto Whole Cell button.
5. Press Auto Cp Fast button.
6. The step response should be ~ 25 mV_{p-p}.

50 M Range

1. Change the feedback resistor to 50 M.
2. Increase Output Gain to 10.
3. Press Auto Whole Cell and Auto Cp Fast.
4. The step response should be $\sim 25 \text{ mV}_{\text{p-p}}$.

Getting Help in the MultiClamp 700B Commander

First, ensure that your computer is connected to the Internet and has a correctly configured web browser with JavaScript (such as Internet Explorer v. 4 or later.). Pressing the  button at the top of the MultiClamp 700B Commander will connect you to the On-line Help, which describes many of the functions of the MultiClamp 700B Commander.

This manual is designed to be used in conjunction with the On-line Help. This manual does not, for example, describe all the buttons and windows in MultiClamp 700B Commander, because this information is better provided in an interactive way using the On-line Help. Rather, the purpose of this manual is to provide tutorials and detailed information about the design and operation of the MultiClamp 700B amplifier as a whole. Therefore, the On-line Help and this manual complement each other. If you have suggestions for improving this manual or On-line Help, we encourage you to submit them to Axon Technical Support.

Chapter 3

Tutorials

The purpose of this chapter is to lead the user through the basics of patch clamping and ‘sharp’ microelectrode recording, using the PATCH-1U model cell that comes with the MultiClamp 700B. The tutorials are designed to illustrate the operation of the MultiClamp 700B and associated Commander control software. Although this chapter is directed primarily at inexperienced electrophysiologists, it may also be useful for experienced researchers who desire a simple introduction to the features of the MultiClamp 700B.

We recommend that you perform the Tutorials in order to avoid confusion.

Check List

These tutorials require the following:

1. MultiClamp 700B main unit, and at least one CV-7 headstage. The tutorials address Headstage #1, but of course you should repeat the tests for Headstage #2 if you have a second.
2. PATCH-1U model cell.

3. Piece of aluminum foil or a metal container, such as a coffee can (in which to place the model cell) grounded to the CV-7 headstage or 4 mm Signal Ground plug on the rear of the MultiClamp 700B.
4. Oscilloscope to monitor the output of the MultiClamp 700B. Alternatively, pCLAMP / Digidata acquisition system could be used to monitor the output.

Model Cell

All of these tutorials use the PATCH-1U model cell, which contains simple circuits of resistors and capacitors designed to simulate three patch clamp recording conditions: (1) Pipette in the bath (Connector labeled BATH on the model cell), (2) Gigaseal (PATCH), and (3) Whole-cell (CELL). The circuit for each of these is as follows. (Also see **MODEL CELL** in Chapter 5.)

BATH: 10 M Ω "pipette" resistor to ground.

PATCH: 10 G Ω "patch" resistor to ground.
Approximately 5 pF stray capacitance to ground.

CELL: 10 M Ω "pipette" resistor.
500 M Ω "cell membrane" resistor in parallel with 33 pF cell membrane capacitor.
Approximately 5 pF stray capacitance to ground.

Tutorial 1 – Electrode in the Bath: Voltage Clamp

1. Switch on the MultiClamp 700B and run the MultiClamp 700B Commander by double-clicking on the shortcut icon on the desktop of the PC. Press the Reset to Program Defaults toolbar button, or press the F6 key.



Figure 3.1

This puts the MultiClamp 700B in V-Clamp mode and directs the Membrane Current (0.5V/nA) signal to the Primary Output BNC connector on the front panel of the amplifier.

2. Plug the BATH connector of the model cell into the white Teflon input connector of the Channel 1 headstage. Connect the 2 mm gold socket on the side of the model cell to the 1 mm gold socket on the rear of the CV-7 headstage, using the short black wire provided with the model cell. Shield the headstage and model cell with the aluminum foil or metal box. Ground the shield by connecting (using an “alligator” clip) to the 1 mm plug inserted previously into the rear socket of the CV-7.
3. Connect a BNC cable from the Channel 1 Primary Output on the front panel of the MultiClamp 700B to the oscilloscope. The oscilloscope display should be set initially at 0.5 V/division and 2 ms/division . Triggering should be set to Line. Alternatively, connect a BNC cable from the Channel 1 Primary Output to and Analog Input on the front panel of a Digidata digitizer for monitoring on the Scope Window of Clampex.

4. Press the Pipette Offset button while looking at the oscilloscope.



Figure 3.2

After making a brief series of steps (due to the MultiClamp 700B's algorithm for finding the offset) the Membrane Current is zeroed. Note also that the Pipette Offset button is grayed out and the padlock icon to the left appears locked.

5. Check the Seal Test checkbox.

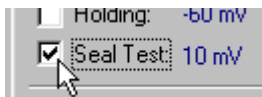

Figure 3.3

A repetitive pulse appears on the Primary output signal. (The trace can be triggered on the oscilloscope screen by making a connection from the SYNC output on the rear of the MultiClamp 700B to the External Trigger input on the oscilloscope. See Options / General tab.) The amplitude of the Seal Test pulse is 10 mV. The amplitude of the Membrane Current output pulse is 0.5 V, which corresponds to 1 nA at the default gain of 0.5 V/nA (shown under Primary Output section).

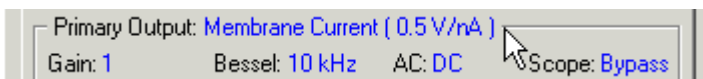

Figure 3.4

Therefore, the resistance of the model electrode is calculated from Ohm's Law to be $R = V/I = 10 \text{ mV}/1 \text{ nA} = 10 \text{ M}\Omega$. Alternatively, check the Resistance checkbox under the Channel 1 meters.

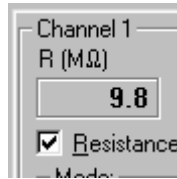

Figure 3.5

The resistance is displayed on the meter. Uncheck the box when done. (DC fluctuations in the signal are due to pulses from the MultiClamp 700B Commander for calculating meter resistance values.)

6. Try changing the Seal Test amplitude and frequency by using the glider control with the mouse. (See **SETTING PARAMETERS IN THE MULTICLAMP 700B COMMANDER** in Chapter 6.)



Figure 3.6

Note how the Primary Output signal changes on the oscilloscope as the test pulse parameters are changed.

Tutorial 2 – Electrode in the Bath: Current Clamp

Note that the model cell used in this tutorial is designed to simulate a patch pipette, rather than a typical intracellular electrode, which generally has a higher resistance. However, the principles illustrated are the same.

1. Set up the MultiClamp 700B and the MultiClamp 700B Commander as in Steps 1-3 of Tutorial 1.

- Press the Mode button labeled IC. The tab labeled I-Clamp 1 will move to front, and the Current Clamp light (green) on the front panel of the MultiClamp 700B unit will illuminate.

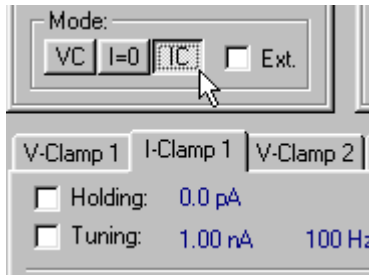

Figure 3.7

Note that the Primary Output signal displayed on the oscilloscope is now Membrane Potential (10 mV/mV).

- Press the Pipette Offset button. This operates exactly like in Voltage Clamp mode. (See Tutorial 1, Step 4.) Note how the Primary Output signal changes on the oscilloscope.
- Check the Tuning checkbox.

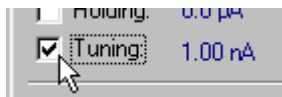

Figure 3.8

A repetitive pulse appears on the Membrane Potential output. The amplitude of the Tuning pulse is 1 nA. The amplitude of the Membrane Potential output pulse is 100 mV, which corresponds to 10 mV at the default gain of 10 V/mV. Therefore, the resistance of the model electrode is calculated from Ohm's Law to be $R = V/I = 10 \text{ mV}/1 \text{ nA} = 10 \text{ M}\Omega$. Alternatively, the resistance can be directly displayed by checking the Resistance checkbox under the Channel 1 meters.

5. Try changing the Tuning amplitude and frequency by using the glider control with the mouse.

Tutorial 3 – Giga Seal Configuration

1. Set up the MultiClamp 700B and the MultiClamp 700B Commander as in Steps 1-3 of Tutorial 1, except that the PATCH connector on the model cell should be plugged into the headstage of the MultiClamp 700B. This connects a 10 G Ω resistor to ground, simulating a gigaseal.
2. One of the advantages of a gigaseal is that the recording noise is dramatically reduced, enabling single-channel measurements. However, to facilitate single-channel recording it is necessary to change the feedback resistor in the headstage of the patch clamp amplifier. For illustration, look at the Channel 1 Primary Output after turning up the vertical gain on the oscilloscope. The noise on Primary Output should be about 5 mV peak-to-peak (p-p), which corresponds to 10 pA (p-p) at the default scale factor of 0.5V/nA. 10 pA is too noisy for most single-channel recording.
3. Press the Options toolbar button at the top of the MultiClamp 700B Commander.



Figure 3.9

This opens the Options panel. Select the Gains tab. You will note that the default Feedback Resistor under Channel 1 Voltage Clamp is 500 M Ω . Increasing the size of the feedback resistor, which is located in the headstage, increases the gain of the headstage. As a rule of thumb, the larger the value of the feedback resistor, the smaller the noise of the headstage but the smaller the range of the output. For this reason, *larger* feedback resistors are usually selected for patch recording, where low noise is more important than range.

(Note the information provided under Experiment Type and Range in the Gains panel.)

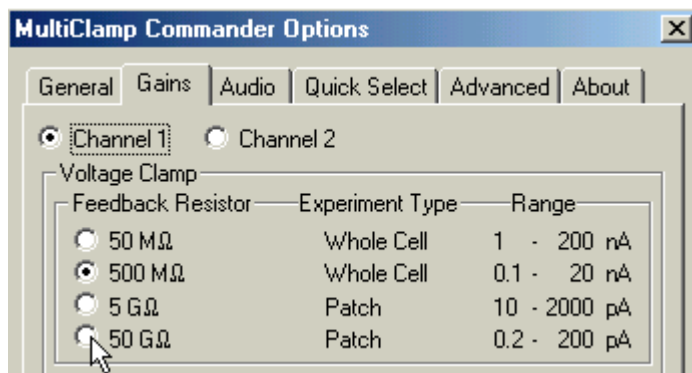

Figure 3.10

Select 50 GΩ feedback resistor and then close this panel.

- Note that the noise trace on the oscilloscope is now about 150 mV_{p-p}. However, the Primary Output gain is now 0.05 V/pA, so the noise is 3 pA_{p-p}, a 3-fold reduction compared with before. This is still quite noisy for recording single-channel currents of a few picoamps. To clearly see small currents, it is necessary to filter the Primary Output.
- Locate the Primary Output section in the main window of the MultiClamp 700B Commander and position the mouse cursor over Bessel: 10 kHz. Using the glider control (see Chapter 2) examine the effect of filtering the Primary Output.



Figure 3.11

Note that with a filter setting of 2 kHz the peak-to-peak noise on Primary Output is about 0.5 pA, which is adequate for most single-channel recording. (See Chapter 4 for practical hints on how to reduce the noise further.)

6. This section of the MultiClamp 700B Commander displays three other adjustable parameters: Output Gain, AC and Scope.
 - Use the glider to adjust Output Gain. Note the changes in the scaling factor at Primary Output: Membrane Current, as well as the change in signal amplitude on the oscilloscope. Unlike changing the feedback resistor range, altering the Output Gain has no effect on the relative amplitude of the (current) noise.
 - AC: allows you to send the Primary Output through a high-pass filter. This may be desirable if you wish to remove a DC offset or low-frequency component in the signal output.
 - Scope is used to filter the signal provided by the SCOPE BNC on the front panel of the MultiClamp 700B. In the default configuration, this BNC simply duplicates the signal available at the Primary Output BNC. However, in some circumstances you may wish to filter the SCOPE signal (normally viewed on an oscilloscope) more heavily than the PRIMARY Output signal being sent to a computer. The Scope parameter in the MultiClamp 700B Commander allows you to do this.

- Open the Options panel and set the feedback resistor to 500M. Close this panel, then reset the Bessel filter to 10 kHz, the Output Gain to 1 and the Seal Test frequency to 200 Hz. Check the Seal Test checkbox; a train of ~1 Volt transients will appear on the Primary Output trace. (These are more easily seen if the oscilloscope is triggered using the SYNC output of the MultiClamp 700B, as described in Tutorial 1.)

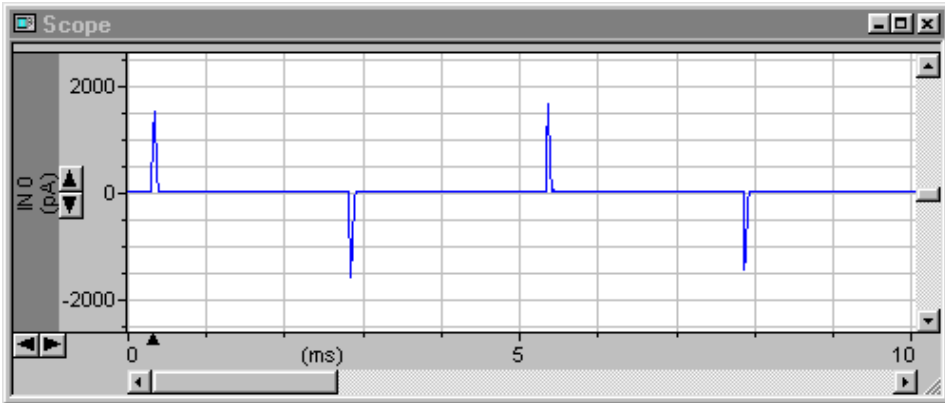

Figure 3.12

The transients result from the charging of the 5 pF capacitance of the model cell, which simulates the capacitance of a patch electrode. In a real experiment these transients are undesirable because they may saturate the amplifier, leading to distortions in the measured currents. They can be eliminated by using the Cp Fast and Cp Slow controls in the main window of the MultiClamp 700B Commander.

8. Place the mouse cursor over the button (dual control) opposite Cp Fast. The cursor changes to crossed arrows. (See the figure below.) While holding down the Shift key (to magnify the movement; see Chapter 2) use the glider, sliding the mouse horizontally and vertically, to change the values of the time constant and capacitance, respectively. Alternatively, you can place the mouse cursor over each parameter display in turn, and use the glider to adjust each individually.



Figure 3.13

Notice that you can change the amplitude and, to a lesser extent, the decay time constant of the transients on the oscilloscope. With Cp Fast capacitance set to about 5 pF the transients should be minimized.

9. An alternative way to cancel the transients is by pressing the Auto button opposite Cp Fast. The algorithm should find optimum values of about 5 pF and 1 μ s. In experiments with real cells you may need to make manual fine adjustments for optimal cancellation.
10. Sometimes an additional, slower capacitance transient is visible after canceling the fast transient in the PATCH configuration (not to be confused with the very slow transient that appears in the CELL configuration, discussed in Tutorial 4.) This can be compensated using the Cp Slow controls. The PATCH setting on the model cell has only a very minor slower transient.

- Now that the capacitance transients are compensated, it will be possible to increase the amplitude of the Seal Test pulse without overloading the MultiClamp 700B. Set the Seal Test amplitude to 100 mV by placing the cursor over the display (10 mV), double clicking and typing 100 <Enter>. Clear steps should now be visible on the oscilloscope, with amplitudes of about 5 mV.

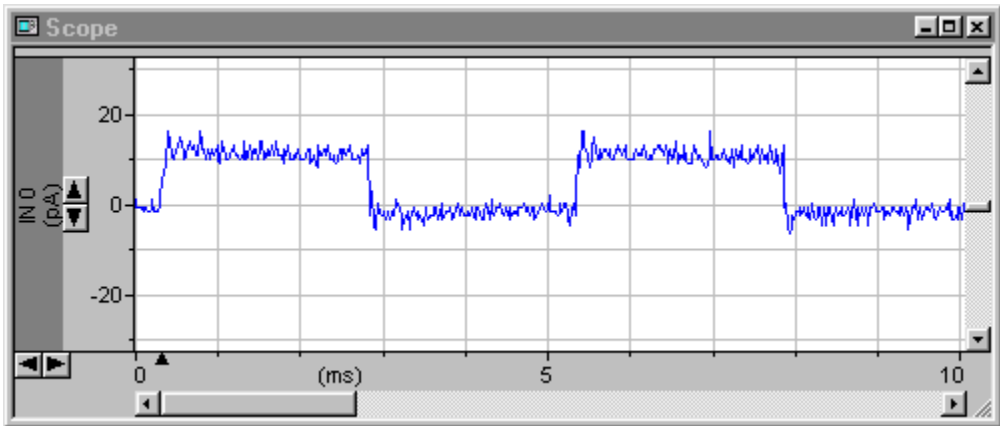

Figure 3.14

With the Primary Output: Membrane Current gain set at 0.5 V/nA, this is equivalent to 10 pA. Hence the resistance of the model patch is calculated from Ohm's Law to be $R = V/I = 100 \text{ mV}/10 \text{ pA} = 10 \text{ G}\Omega$. Alternatively, check the Resistance checkbox under the Channel 1 meters.

Tutorial 4 – Whole-Cell Configuration: Voltage Clamp

- Reset to Program Defaults and set Seal Test frequency to 200 Hz. Plug the CELL connector on the model cell into the CV-7 headstage.

2. Check the Seal Test checkbox; a train of ~ 0.5 Volt transients decaying over ~ 2 ms will appear on the Primary Output trace. (These are more easily seen if the oscilloscope is triggered using the SYNC output of the MultiClamp 700B.)

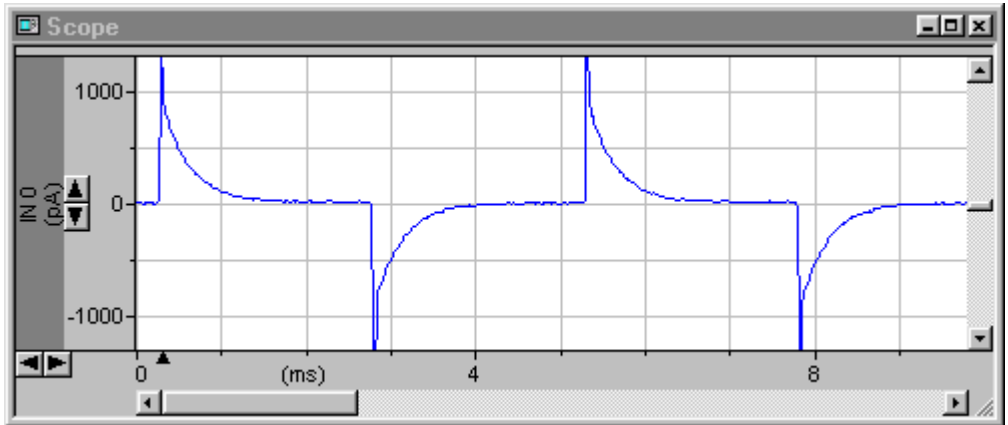

Figure 3.15

The fast component of the transients reflects the simulated electrode capacitance (5 pF), while the slow component reflects the capacitance of the simulated cell (33 pF). Following the 10 mV Seal Test step the transients decay to a plateau of 10 mV, equivalent to a current of 20 pA. This yields a resistance of $10 \text{ mV}/20 \text{ pA} = 500 \text{ M}\Omega$, which is the “input resistance” of the model cell. This can also be found by checking the Resistance checkbox under the meters.

3. In a real cell, the holding potential would have been set prior to going to whole-cell mode. Set the holding potential now by checking the Holding checkbox and using glider control to apply a negative holding potential (*e.g.* -60 mV).

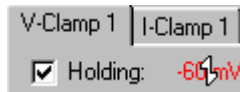

Figure 3.16

4. We now wish to cancel the slow component of the transient, because (a) it may, like the fast transient, saturate the headstage amplifier, and (b) this cancellation is necessary for proper series resistance compensation (see step 8, this Tutorial). Check the Whole Cell checkbox and use the toggle button to adjust the capacitance (pF) and series resistance (M Ω) parameters. It will be easier to do this while holding down the Shift key to accelerate the effect of mouse movement.

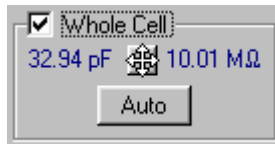

Figure 3.17

- It should be possible to compensate completely the slow transient. The optimal values will be around 33 pF (the model cell capacitance) and 10 M Ω (the model electrode resistance). Note that a small, fast transient may reappear after the slow one is canceled. This can be removed by again pressing the Cp Fast Auto button.
5. An alternative way to cancel the slow transient is by pressing the Auto button. Try this, after first using glider control to set the pF and M Ω values to “wrong” values, such as 100 pF and 100 M Ω . After imposing a series of voltage steps on the model cell, the algorithm should converge on about 33 pF and 10 M Ω . In real experiments it may be necessary to make manual adjustments for optimum cancellation of the slow transient.
 6. Press the Auto button opposite Cp Fast. This will cancel the fast component of the transient.

The residual step, due to current flow through the “input resistance” of the model cell, can be canceled using the Leak Subtraction feature of the MultiClamp 700B. This subtracts from Primary Output a current that is scaled linearly from the voltage command. (See Chapter 5, **LEAK**

SUBTRACTION). Check the Leak Subtraction checkbox and press the button (or use the glider to obtain a flat trace).

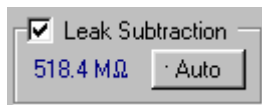

Figure 3.18

The optimum value is about 500 MΩ, the “input resistance” of the model cell. Manual adjustments of Whole Cell and Cp Fast may be necessary to perfectly compensate the response.

Directly to the left of the Leak Subtraction button is the Output Zero button, which provides a slightly different way of removing offsets in the Primary Output trace. Output Zero acts like a high-pass filter, subtracting a constant DC offset without regard to the voltage command. To illustrate its use, switch off Leak Subtraction, and check and press Output Zero (with Holding set to a large negative value, as described in step 3 of this Tutorial). The Primary Output trace is baselined but unlike with Leak Subtraction, the step due to Seal Test is not subtracted.

7. The series resistance (R_s), which typically originates near the tip of the recording electrode, can be thought of as an unwanted resistance that is interposed between the headstage circuitry and the membrane of the cell. Since R_s can cause serious errors in voltage clamp mode, it needs to be reduced as much as possible. This can be done both mechanically (*e.g.* by using lower-resistance electrodes) and electronically. Full details are given in Chapter 5, but the following exercise gives a foretaste of electronic R_s compensation.

Ensure that Seal Test is running (10 mV, 100 Hz) and both Cp Fast and Whole Cell compensation have been adjusted as at the end of step 6 above. Switch off Output Zero and Leak Subtraction and increase Seal Test amplitude to 50 mV. The relatively slow rise in the Primary Output current trace (~ 1 ms) is a manifestation of series resistance error. The goal is to speed up this risetime using R_s compensation.

- Check the Rs Compensation checkbox, set Bandwidth to 5 kHz, and ensure that the Prediction and Correction controls change together.



Figure 3.19

Using glider control, slowly advance the percent setting under Prediction or Correction while watching the Primary Output trace on the oscilloscope. The trace becomes noisier, the rising edge is speeded up, and a transient develops at the rising edge. As the settings are increased beyond about 80% the transients become larger, and then rapidly escalate into a full-blown oscillation. The art of Rs compensation is to choose a combination of Bandwidth, Prediction and Correction that provides maximal compensation without oscillation. Full details are given in *SERIES RESISTANCE COMPENSATION* in Chapter 5.

- The MultiClamp 700B is designed to be used with an external pulse generator or computer to provide voltage-clamp (and current-clamp) command steps. However, the Pulse button in the MultiClamp 700B Commander allows you to apply simple, on-off steps with a selectable amplitude and duration.



Figure 3.20

Experiment with different pulse settings, monitoring the Primary Output trace while repeatedly pressing the Pulse button. Note that only a discrete list of pulse durations is allowed (seen by positioning the mouse over the duration field and clicking the right button).

Tutorial 5 – Whole-Cell Configuration: Current Clamp

1. Reset to Program Defaults. In the Gains tab of the Options menu, select the 50 M Ω range in the Current Clamp section.
2. With the model cell in the CELL position, click Auto Pipette Offset.
3. Under Channel 1 Mode: press the button labeled IC. The tab labeled I-Clamp 1 appears, the Current Clamp light (green) on the front panel of the MultiClamp 700B unit illuminates, and Primary Output displays Membrane Potential.
4. Check the box next to “Holding” and, using glider control, vary the holding current (pA) while viewing the Primary Output signal on the oscilloscope and on the MultiClamp 700B Commander voltage meter. The model membrane potential varies smoothly with Holding current.

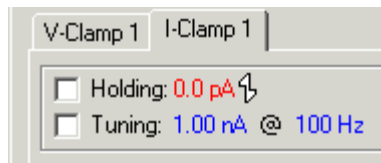

Figure 3.21

5. Switch off Holding and check the Tuning checkbox while monitoring Primary Output on the oscilloscope. This injects a repetitive square current pulse into the current clamp circuit.

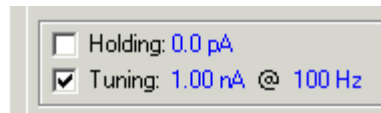

Figure 3.22

A sawtooth pattern appears on Primary Output (Figure 3.23). Each segment of the sawtooth is actually an incompletely relaxing exponential.

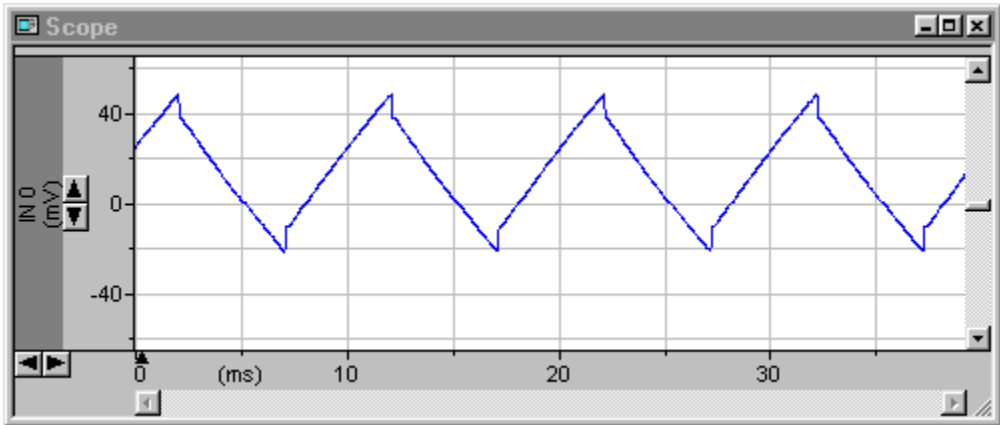

Figure 3.23

- Set the Tuning frequency to 50 Hz and note that, on an expanded oscilloscope timebase, a step is visible at the beginning of each segment of the sawtooth. This step is due to the resistance of the model “electrode”. As in the case of whole-cell voltage clamp, electrode series resistance can introduce errors to current-clamp recordings and needs to be compensated electronically. In current-clamp mode, R_s is compensated using Bridge Balance.



Figure 3.24

Check the Bridge Balance checkbox and, using glider control, vary the $M\Omega$ value until the step is eliminated. Alternatively, press the Auto Bridge Balance button for automatic adjustment. The electrode resistance of the model cell is $10 M\Omega$, but in the CELL position you may record slightly higher values (near $14 M\Omega$) because the electrode resistance is mixed with the cell capacitance and resistance components.

To the left of Bridge Balance is the Output Zero button. This works exactly like the corresponding button in voltage clamp, removing constant DC offsets.

- In current-clamp mode the stray electrode capacitance can cause additional errors, acting to filter the membrane potential signal. This error can be reduced by using electronic compensation of the pipette capacitance.

While holding down the Ctrl key to magnify mouse movement, use glider control to increase the Pipette Capacitance Neutralization (pF) value while monitoring Primary Output on the oscilloscope.

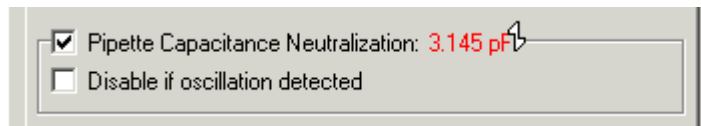

Figure 3.25

Note that, as you increase the value beyond about 3 pF, damped oscillations start to appear at the beginning of each sawtooth.

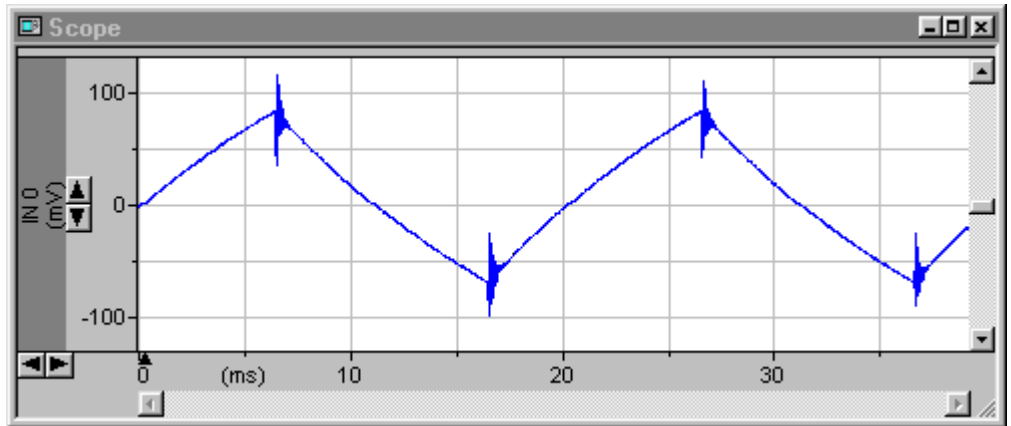

Figure 3.26

If you go further still, full-scale oscillations develop. Increase the value until you see full oscillations, then reduce the value until your output again looks like Figure 3.26.

8. As in the case of R_s compensation in voltage-clamp mode, the art of pipette capacitance neutralization is to increase the neutralization as far as possible without provoking oscillations that may be harmful to your cell (see further details in the Reference section). But no matter how carefully you compensate capacitance to begin your experiment, it is still possible to experience oscillations later in an experiment because electrode properties (*e.g.* resistance, junction potential) may change over time. The MultiClamp 700B provides you with an option to protect your cell from harmful oscillations during a current-clamp experiment by automatically disabling (or alternatively, reducing) Capacitance Neutralization. (In a similar manner, Series Resistance compensation can be disabled or reduced in Voltage Clamp.)

Check the box beneath Pipette Capacitance Neutralization labeled, “Disable if oscillation detected”.

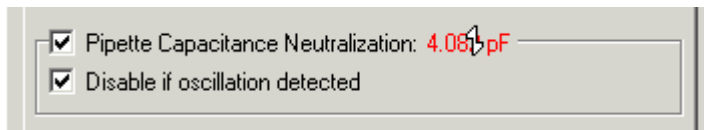

Figure 3.27

9. Now, increase the Pipette Capacitance Neutralization until you reach a value that evokes full-scale oscillations. The automatic protection circuit will work quickly to disable the Pipette Capacitance Neutralization, and several things will happen:
- To the right of the “Disable...” field, a small icon will appear briefly to display repeated images of a sine wave that is reduced to a flat line.
 - The Pipette Capacitance Neutralization feature will be disabled (box will become unchecked).
 - You will hear an audible tone.

- A warning message will appear to indicate the detection of oscillations and the disabling of Pipette Capacitance Neutralization.

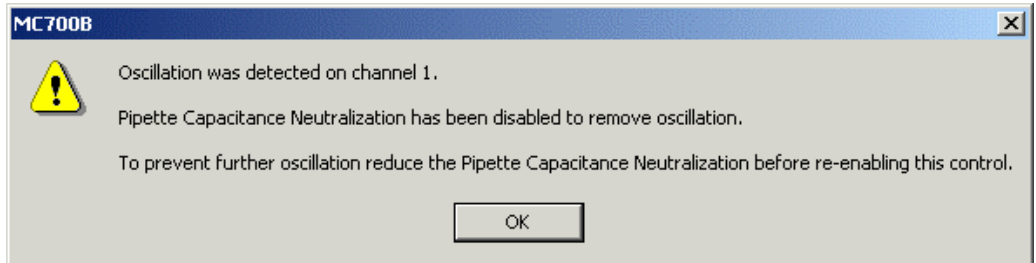

Figure 3.28

10. You can choose to prevent the warning message from appearing. Go to the Options / Auto menu, and disable (uncheck) the “Display warning” feature.

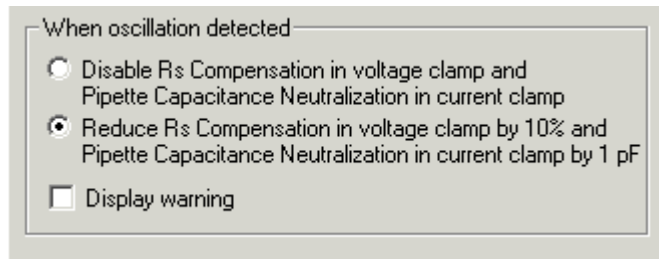

Figure 3.29

Also in the Options / Auto menu, you can alternatively choose to *reduce* instead of disable Pipette Capacitance Neutralization in IC mode.

Neutralization will be iteratively reduced by 1 pF steps until oscillations are no longer detected. (Note also that this menu applies a similar reducing effect to Series Resistance compensation if oscillations are detected in VC mode.)

11. Check on the “Reduce Rs Compensation...” radio button in the Options / Auto menu. Close this menu, then repeat step #8 above to evoke oscillations. (Note that the warning dialog will not be shown this time after the automatic reduction of Pipette Capacitance Neutralization, because you have disabled this feature in the Options menu.)

- Turn off the Tuning pulse. Set Holding to 0 pA. Set your oscilloscope time scale to view at least 2 seconds per sweep.
- Below the Holding / Tuning section, see the feature labeled, “Inject slow current to maintain potential at:” Set the potential to -100 mV, and the time constant to 500 ms.

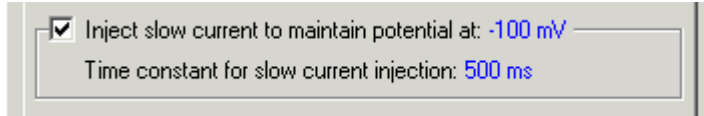

Figure 3.30

- Check the box to activate the slow current injection feature, and monitor the Primary Output Membrane Potential on the oscilloscope. You should note a voltage deflection from 0 V to -1 V (since the scale factor is 10 mV/mV). The deflection will require approximately 500 ms to reach steady state.

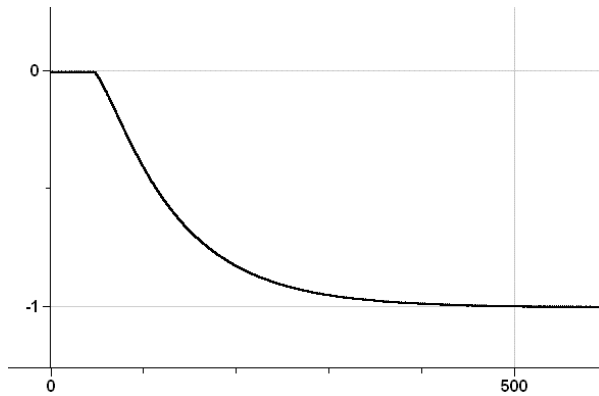

Figure 3.31

The time required to reach the selected voltage depends upon the feedback resistor and headstage load. See the MultiClamp 700B Commander on-line Help for more detail.

- The Pulse button in current clamp allows you to apply single current steps of variable amplitude and duration. Experiment with different settings for Pulse amplitude and duration while monitoring the effect on Primary Output.



Figure 3.32

- Switch on both Holding and Tuning features. Observe Primary Output on the oscilloscope while pressing the I=0 button.



Figure 3.33

I=0 is a special mode of current clamp in which all command inputs are disconnected. With the model cell, the Primary Output Membrane Potential signal returns to near 0 mV when I=0 is pressed. In a real cell the Membrane Potential would return to the resting potential of the cell. See **IMPALING CELLS** in Chapter 4 for detailed information on current clamp experiments with real cells.

Tutorial 6 – Whole-Cell Configuration: Automatic Mode Switching

- Set up MultiClamp 700B as follows: Reset to Program Defaults, connect CELL position of Patch-1U model cell (shielded and grounded) to CV-7 headstage.
- Make the following changes in VC mode:
 - Click Auto Pipette Offset.
 - Turn on Seal Test (check box).
 - Click Auto Cp Fast.

- d. Set Holding value to 20 mV, and check box to activate.
 - e. Change Primary Output signal to read Membrane Potential (10 mV/mV). In a real experiment, you might consider simultaneously recording *Membrane Current* on a different channel.
3. Change Mode to Current Clamp by clicking IC button. Set Tune pulse for 100 pA @ 2 Hz, then check box to activate.
 4. Click on the Options / Auto tab. In the *Switch to voltage clamp* section, click the radio button for *On negative-to-positive V_m threshold crossing*. Set *Delay change to voltage clamp* = 0 ms, and *Membrane Potential (V_m) threshold* = 20 mV. Next, click the radio button for *Return to current clamp: After:*, and set this value to 500 ms. Close the Options menu to return to the main IC window.

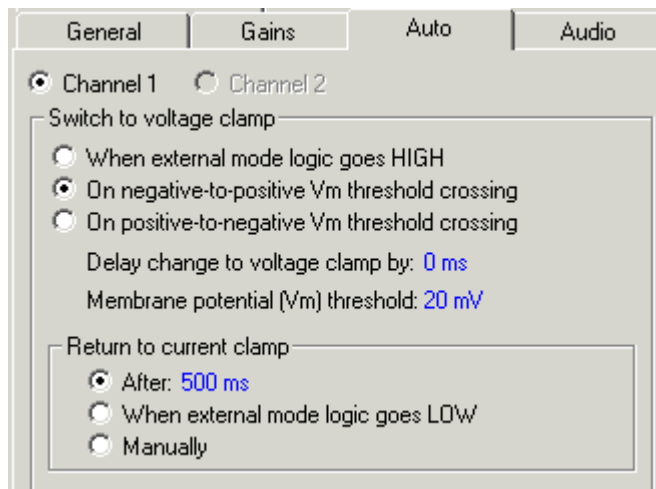

Figure 3.34

5. Monitor Primary Output on external oscilloscope. Set display for at least 2 full seconds per sweep. You should observe a slowly charging and discharging voltage response to the Tune current step.

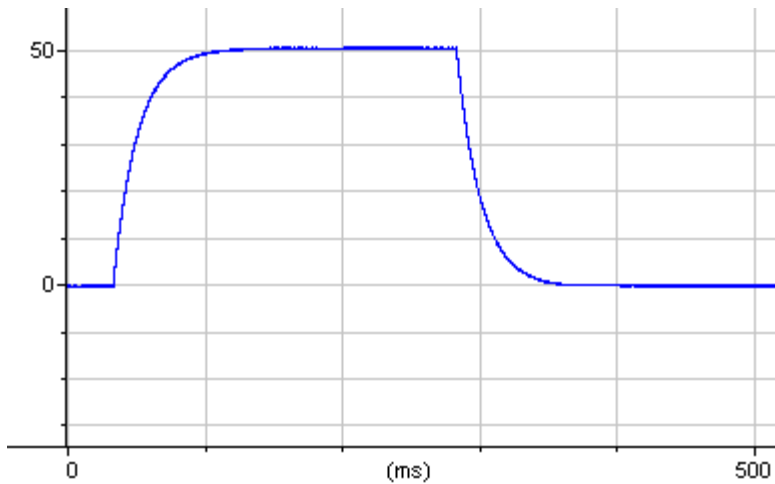

Figure 3.35

6. Now check the *Auto* checkbox next to the Mode buttons. Note that the VC, I=0 and IC buttons are now greyed out, since they are under automatic control.



Figure 3.36

7. Monitor the Primary Output on the oscilloscope. You should now observe the following events (see figure below):
 - a. A switch from IC to VC when the negative-going deflection of the membrane potential reaches 20 mV.

- b. MultiClamp 700B will remain in VC for 500 ms, then switch back to IC. A transient due to this mode change will appear, then the potential will begin to decay.
- c. When the potential again reaches 20 mV (going from positive to negative direction), the MultiClamp 700B will again switch from IC to VC. This latter process will continue until the Auto mode switch is unchecked.

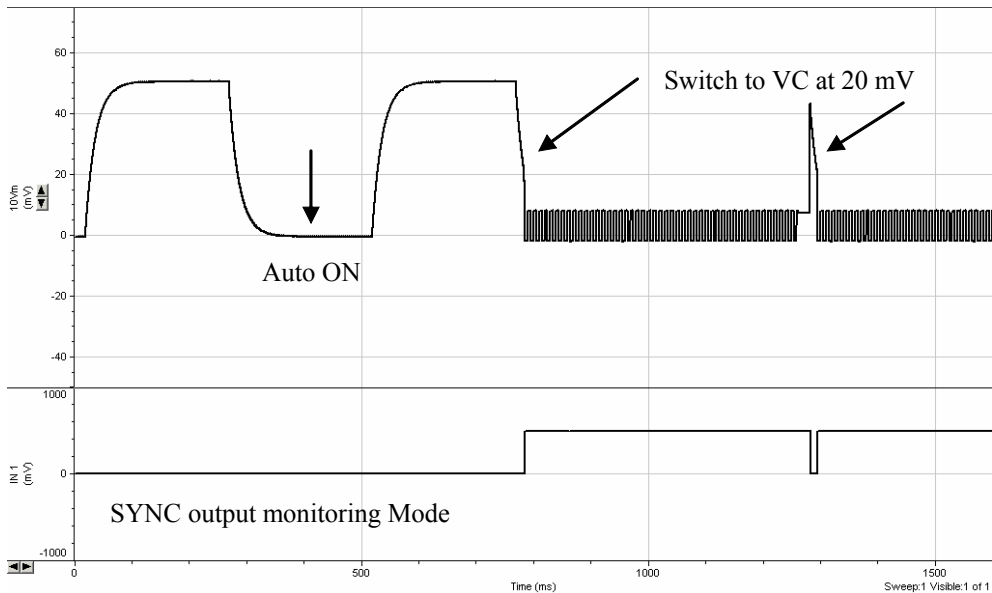

Figure 3.37

8. The lower trace in the figure above shows a recording from the SYNC output on the rear of the MultiClamp 700B. In the Options / General tab, select “Mode on channel 1” to follow the mode switching event. A deflection to 5 V indicates VC mode, while 0 V is the output during IC mode.
9. **Note:** During a real experiment, if you are using an external command input to the MultiClamp 700B (such as the output of a Digidata), then you must be

careful to turn OFF this external command during the Auto Mode switch. If you do not, then the incoming command will conflict with the Auto Mode switch settings. To disable the external commands, go to the Options / Gains tab, and click the OFF radio button in the VC and IC External Command Sensitivity sections.

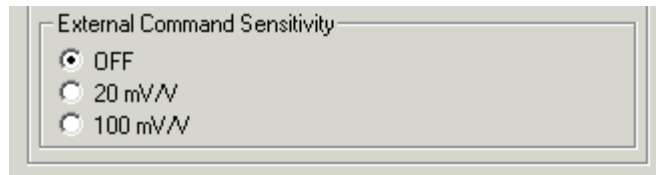

Figure 3.38

10. Experiment with different settings (Threshold crossing, Delay, V_m , and Return) in the Options / Auto tab, in order to appreciate the flexibility of this automatic Mode-switching feature.

Chapter 4

Guide to Electrophysiological Recording

The purpose of this chapter is to provide practical advice on patch clamping and sharp microelectrode recording, both of which are possible using the MultiClamp 700B. It includes both tutorial-style guidance and technical details for reference. This information has been distilled from textbooks on the subject (see References at the end of this manual) and from experienced researchers working in laboratories around the world. However, as is the case for all advice (and particularly that pertaining to research), the suggestions given here should be taken as provisional until they have been tested in your own circumstances.

This chapter has been divided into three parts: (1) general advice for *in vitro* electrophysiology, (2) patch clamping, and (3) sharp microelectrode recording.

General Advice

Chamber Design

The tissue chambers used in many *in vitro* electrophysiological experiments usually have four main requirements:

- a perfusion system for keeping the tissue alive and applying drugs
- a method for keeping the tissue mechanically stable
- optical properties suitable for observing the tissue and positioning electrodes
- an electrically stable bath (reference) electrode

Perfusion

Normally the external solution used in *in vitro* experiments is a pH-buffered salt solution that mimics the extra- or intracellular composition of the cells under study. Sometimes the solution is bubbled with CO₂ (to maintain the pH of bicarbonate-buffered solutions) and/or O₂ (to maintain the metabolic viability of the cells). Some cells (*e.g.* those in retinal slices) have unusually high metabolic rates and require fast perfusion with high-O₂ solution to remain viable. Other cells (*e.g.* neurons in dissociated cell culture) may not need any perfusion or bubbling at all. Because the health of the cells is the single most important factor in determining the success of your experiments, it is worth spending some time establishing the optimal conditions for cell survival.

Mechanical Stability

Patch clamp recordings can be surprisingly robust in the presence of vibrations. However, sharp microelectrode recordings are not so robust in the presence of vibrations. Neither type of experiment is tolerant of large drifts in the tissue or electrode that tend to pull the electrode out of the cell. For this reason, it is important to use a good, drift-free micromanipulator for the electrode, and to secure the tissue or cells in the chamber so they cannot move very far. Tissue slices are

commonly held in place in the chamber by a weighted “net” or “grid” of fine threads.

A grid is easily made as follows. Bend a piece of 0.2-0.4 mm diameter platinum wire into a ring small enough to fit in the bottom of your chamber, then flatten the wire in a vise. Using a pair of fine forceps, pull a single strand of nylon thread off a ~1 m length of unwaxed nylon dental floss. (It is very wispy but remarkably strong.) Wrap the thread tightly in a spiral around a strip of thin black card about 3 x 10 cm, securing each end with sticky tape. Bending the card slightly, slip the flattened platinum ring under the threads, and adjust its position and the spacing of the threads until the optimal grid pattern is obtained. Finally, add a tiny spot of cyanoacrylate glue to each thread crossing point and, after it is dry, cut the completed grid free.

Optics

Again, it is difficult to generalize about the optical requirements of the chamber, since the optical technology in use may range from a simple dissection scope to a multiphoton microscope. In general, however, it is probably best to build a chamber with a glass microscope coverslip forming the bottom, to ensure the best possible optical clarity.

Bath Electrode

The simplest kind of bath electrode is a chlorided silver wire placed in the bath solution. However, if the chloride ion concentration of the bath is altered by perfusion during the experiment, this kind of electrode will introduce serious voltage offset errors. In this case it is essential to use a salt bridge for the bath electrode. (See **BATH HEADSTAGE AND ELECTRODES** in Chapter 5.) In any case, it is good practice, at the end of every experiment, to check for drift in electrode offsets. This is easily done by blowing out the patch and pressing the I=0 button on The MultiClamp 700B Commander. This will display on the meter the pipette voltage required for zero current through the electrode. If, for instance, the meter shows 2 mV, there has been a 2 mV drift since the electrodes were nulled at

the beginning of the experiment, and your voltage values may be in error by at least this amount. Large offset errors may indicate that your electrode wires need rechloriding, or a fluid leak has developed in your chamber, causing an electrical short circuit to the microscope.

Note: If you use both headstages on the MultiClamp 700B (*e.g.* for making simultaneous recordings from pairs of cells) you may wonder whether one or both headstage ground sockets need to be connected to the bath electrode. We have found empirically that the noise in the recordings depends on which headstage is grounded and what mode it is in (V-Clamp or I-Clamp). It is helpful to have a wire connected from each headstage to the bath electrode, with the connection able to be switched off by a toggle switch without bumping the electrode. In this way the best grounding configuration can be established during the experiment.

Interfacing a Computer

Because the MultiClamp 700B is a computer-controlled instrument, the installation of a computer in your electrophysiology rig is obligatory. The minimum computer configuration requires a USB port for communicating with the MultiClamp 700B. However, in order to make full use of the power and convenience of your computer, it is recommended that you also attach a digitizing interface, such as the Digidata 1322A. An interface allows you to generate command signals and save the data in a very flexible manner, without the cost and complexity of a conventional system based on stimulators, digital oscilloscopes, laboratory tape recorders and chart recorders. Digitizing interfaces are typically connected to the computer via a card (*i.e.*, a SCSI card) that is provided with the interface. Finally, it is necessary to install software to control the interface. Software is available from Axon Instruments (*e.g.* pCLAMP) or other vendors, or you can write your own. The beauty of the MultiClamp package is that you are not tied to any particular PC data acquisition software. Any PC-based software that is able to control the digitizing interface is acceptable, while the MultiClamp 700B Commander runs in the background controlling the MultiClamp 700B.

Computer Noise

Digital computers can generate considerable electrical noise, both via the power ground and via radiative interference from the monitor. For optimal noise performance of the MultiClamp 700B, careful attention should be paid to the placement of the computer. For example, the monitor should not be placed immediately above or below the MultiClamp 700B in the instrument rack. Other advice on noise reduction is given in the **NOISE** section of Chapter 5.

Patch Clamping

The patch clamp technique enables stable, low-resistance access to the interior of many cell types. Once this access is established, it is up to the experimenter, of course, whether to record in V-Clamp or I-Clamp mode. However, the discussion in this Part will assume that V-Clamp mode is being used, at least for the initial steps of seal formation and gaining whole-cell access. Once in the whole-cell configuration, you can switch to I-Clamp mode. Advice on recording in I-Clamp mode is given in the following section, “Sharp Microelectrode Recording”.

Headstage and Holder Considerations

Ensure the headstage is securely attached to the micromanipulator using one of the mounting plates on the headstage case. Before attaching the pipette holder, or inserting a pipette in the holder, be sure to touch grounded metal to discharge any static charge that may have inadvertently built up on you or on the holder. Attach a piece of flexible tubing to the suction port on the side of the holder, arranging the tubing in such a way that it will not pull on the holder, even if you unintentionally tug on the tubing while applying suction.

Before using the holder in a real experiment, check for leaks. Insert an unfilled patch pipette in the holder, apply moderate suction by mouth, and then allow the end of the tube to seal against your upper lip. The tube should remain stuck to your lip indefinitely, were you prepared to wait. If it falls off in a few seconds, check that the cone-washers (or O-rings) in the holder are tight.

In patch clamping, and particularly if you are a beginner, it is very useful to have a means of calibrating the amount of pressure or suction that is applied. This allows you to reproducibly apply successful patch clamping strategies, or to systematically alter unsuccessful ones. Ideally, you would attach a manometer to your suction system. A less accurate but cheaper way is to use a 10 cc syringe. Set the syringe at the 5 cc mark and attach it to the headstage suction tubing. The pressure in the tubing (in millibars) is then given approximately by the formula:

$$\text{Pressure (mbar)} \approx -70 * x + 350$$

where x is the mark on the syringe to which the plunger is depressed or withdrawn. For example, depressing the syringe to 4 (cc) will give about 70 mbar of pressure. This formula assumes about 2 m of 1/16" i.d. tubing is attached to the headstage holder. Be aware that any air leaks in your system will nullify this estimate. If you do not explicitly check for leaks, the only indication that a leak exists may be an inability to get seals.

Some researchers prefer to apply pressure and suction by mouth. In this case, it might be useful to roughly “calibrate your mouth” using the syringe method.

Note the following pressure conversion factors:

$$1 \text{ psi} \equiv 70 \text{ mbar}$$

$$100 \text{ mbar} \equiv 75 \text{ mm Hg}$$

The pipette holder is a potential source of electrical noise if it becomes moist. For this reason, electrodes should be filled with solution only far enough that the end of the holder wire or pellet is immersed. Further details are given under “Low Noise Techniques”, below.

Forming a Gigaseal

Start with the MultiClamp 700B in voltage clamp mode (VC). Fill a patch pipette with internal solution and secure it firmly in the pipette holder (fill the patch pipette with external solution if cell-attached recording is the goal). Be sure to support the headstage with your other hand so that the micromanipulator will not have to absorb your force. Apply about 30 mbar of positive pressure to the holder tubing, then lower the pipette tip into the bath. Any voltage offset between the bath electrode and the patch electrode will show up as a non-zero tracking voltage on the I (nA) meter of the MultiClamp 700B Commander. Press the Pipette Offset button to null the offset. Remember that the Pipette Offset does not permanently remove liquid junction potentials in whole-cell recordings (the liquid junction potential returns after the whole-cell configuration is achieved).

Note: Check the stability of your bath (ground) and patch (recording) electrodes. Drifting electrodes will cause a continual current drift off zero, indicating that the electrodes probably need to be rechlorided.

Check the Seal Test checkbox and observe the “Primary output: Membrane Current” on a scope; the trace should resemble the top trace in Figure 4.1. Note the electrode resistance by checking the Resistance checkbox. Lower resistances (2-4 M Ω) are preferred for whole-cell recording (to minimize series resistance), but if the resistance is too low it can be difficult to obtain a gigaseal. Higher resistances (>5 M Ω) are obviously necessary for sealing onto smaller cells or processes. Apart from these basic rules, choice of the appropriate electrode resistance is largely a matter of experience and experimental design.

The method of approaching the cell depends upon whether it is in a “clean” environment (cell culture) or “dirty” environment (intact tissue). For a cell in culture, you can maintain the positive air pressure at about 30 mbar. Lower the pipette until it just touches the cell. As you press harder, causing dimpling of the surface of the cell, you will see the electrode resistance increase, appearing as a decrease in the size of the current pulse (Figure 4.1, three upper traces).

For a cell in a piece of tissue (e.g. a brain slice) you should increase the air pressure to about 80-120 mbar *before* the electrode tip touches the surface of the tissue. This is to help the electrode punch through the surface debris. Once inside the tissue, it may help to reduce the pressure to 30-50 mbar, so you are not simply blowing cells away from the tip of the electrode. If you are “blind” patch clamping in a slice, slowly advance the electrode while looking for a *sudden* increase in resistance, indicating that you have encountered a cell. A *slow* increase probably means the tip is becoming clogged, in which case you can try blowing it out with high pressure before advancing again at lower pressure.

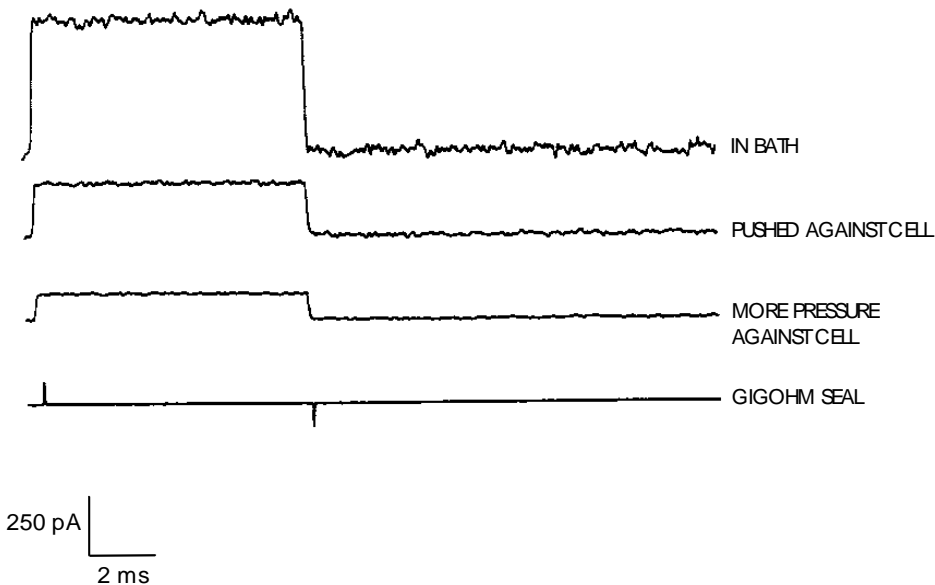

Figure 4.1 Change in resistance while forming a seal.

When you are pushed up against a cell, apply 50-100 mbar of suction (negative pressure) to the pipette holder. At the same time, steadily increase the holding potential towards -60 or -70 mV; doing this usually helps seal formation. There should be a rapid increase in the resistance. Release the suction when the resistance

reaches a gigohm. The resistance often continues to increase slowly over the next several minutes.

The best gigaseals are those that form nearly instantaneously. If a seal does not form within about a minute, continued suction is usually pointless. It is best to change electrodes and try again.

Once the gigohm seal is established, the rectangular current pulse will disappear entirely and be replaced by capacitance transients in synchrony with the rising and falling edges of the command pulse (Figure 4.1, lowest trace). These can be canceled by pressing the “Cp Fast: Auto button”. You may need to manually adjust the capacitance (pF) and time constant (μ s) parameters for optimal cancellation. (See Chapter 3, **TUTORIAL 3**.) A slower component of the transients may be reduced using the Cp Slow controls.

If you wish to remain in cell-attached mode (for example, to record single-channel currents) you should increase the value of the feedback resistor in the headstage in order to reduce instrument noise. (See Chapter 3, **TUTORIAL 3**.) This is done under the Options button at the top of the MultiClamp 700B Commander. After changing the feedback resistor you may need to readjust the Cp Fast and Cp Slow settings.

If you intend to apply voltage steps to the patch, you may wish to use the Leak Subtraction feature of the MultiClamp 700B. This subtracts a scaled (divided by the resistance) version of the command pulse from the membrane current signal, and is particularly intended for use at high gains where the interesting single-channel currents are sitting on top of a leak current that may saturate the digitizing interface. The operation of this feature is described in Chapter 3, **TUTORIAL 4**.

Whole-cell Voltage Clamp Recording

Obtain a gigaseal as described above. The electrode should contain a low Ca^{2+} solution (*i.e.*, buffered with EGTA to ~ 100 nM) that mimics the intracellular milieu, and the electrode resistance should be low (~ 3 -4 M Ω). During or immediately after seal formation, set the holding potential (Holding:) in the

MultiClamp 700B Commander to the anticipated resting potential of the cell (typically ~ -60 or -70 mV). Alternatively, the holding potential can be set in Clampex.

A pulse of strong suction is applied to rupture the cell membrane. This can again be done by mouth suction or by a syringe. Mouth suction tends to give the best control. Apply brief (~ 0.5 s) pulses of suction, starting gently (*e.g.* ~ 80 mbar) and increasing the suction after every couple of pulses until a large capacitance transient suddenly appears (Figure 4.2). If you are using a 10 cc syringe, draw back on the plunger until the capacitance transient appears, but be prepared to quickly release the suction as soon as this occurs so the cell is not sucked up into the electrode.

The MultiClamp 700B contains a Zap circuit to aid in breaking into the cell. This circuit delivers a pulse of 1 V DC to the patch for variable durations ranging from 0.1 to 10 ms. Start with the Zap duration at 1 ms then depress the Zap button in the MultiClamp 700B Commander. A successful break-in will again look like that in Figure 4.2. If the patch is not disrupted, the Zap duration can be increased and the Zap applied a second time, and so on. Some investigators have found that the application of moderate suction while the Zap pulse is given results in a higher incidence of successful patch disruption. The reappearance of the original rectangular pulse either means that you have lost the seal or that the cell does not have a large input resistance. It is not unusual for small cells to have an input resistance of several gigohms but with active conductances it might be as low as a few tens of megohms.

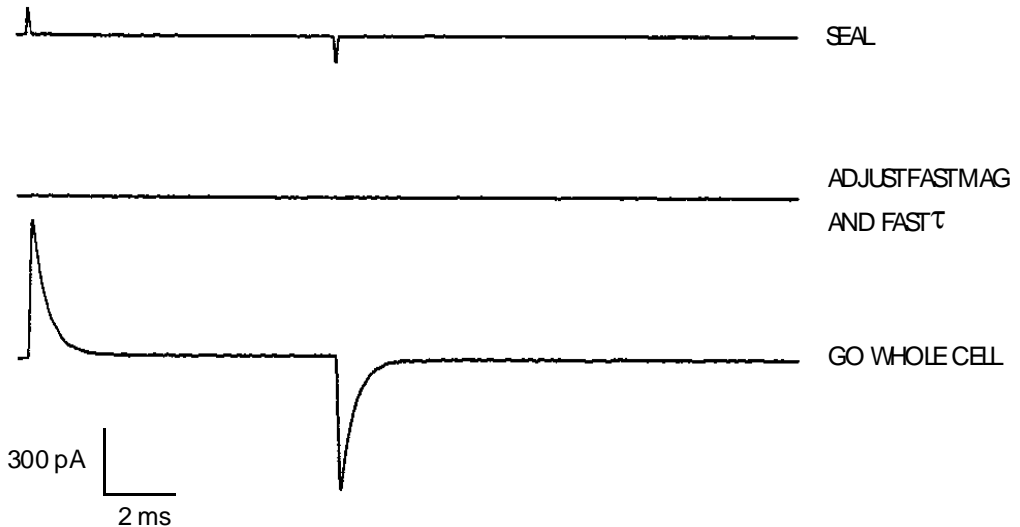

Figure 4.2. Going whole-cell: capacity transients observed when rupturing the patch.

After achieving stable whole-cell access, press the Auto button in the Whole Cell section of the MultiClamp 700B Commander to compensate the whole-cell capacitance transient. It may be necessary to manually adjust the Whole Cell pF and $M\Omega$ values for optimal compensation, and to readjust the Cp Fast values slightly. You should end up with a reasonably square current step, the amplitude of which reflects the input resistance of the cell. (See Chapter 3, **TUTORIAL 4**.) The Whole Cell pF and $M\Omega$ values are estimates of, respectively, the cell's membrane capacitance and the access resistance due to the electrode plus any resistive contribution from the cell's contents. The access resistance is typically about 3 times the electrode resistance, if a clean "break-in" has been achieved. Access can sometimes be improved by applying further pulses of suction or, more dangerously, by brief pulses of pressure.

Whenever voltage clamping in whole-cell mode, it is advisable to use Rs compensation to minimize the voltage drop across the access resistance. A

common mistake is to assume that this R_s error is small, so as to avoid the fiddly process of setting R_s compensation. This is false economy. R_s errors can be surprisingly large and can easily render your hard-won data meaningless. We strongly recommend that R_s compensation be used, at least to convince yourself that its use is unnecessary in your particular case. The theory and practice of R_s compensation are described in Chapter 5, **SERIES RESISTANCE COMPENSATION**.

The Leak Subtraction feature of the MultiClamp 700B allows you to subtract linear leak currents from the membrane current traces. Generally speaking it is not a good idea to do this in the whole-cell configuration, because whole cells may contain background currents that have some dependence on voltage. Software packages like pCLAMP allow a user-specified after-the-fact leakage correction, which is a much safer procedure.

Perforated-patch Recording

With some cells it has proven nearly impossible to go whole cell without loss of seal. If you have one of those cells, you might consider the “perforated patch” technique. In this approach, the very tip of the pipette is filled with a normal filling solution and the rest of the pipette is backfilled with the same filling solution to which 120-150 $\mu\text{g/ml}$ of the pore-formers Nystatin, Amphotericin B or Gramicidin [from a stock solution of 30 mg/ml in DMSO] has been added (Rae *et al.*, 1991; Yawo & Chuhma, 1993). Gramicidin has lower conductance than the other two, but it offers the advantage that it is impermeable to chloride ions, which may be important in some applications (Ebihara *et al.*, 1995). A cell-attached seal is then formed on the cell. Over a 5-30 minute time period, myriad tiny cation-selective, voltage-independent channels are inserted in the membrane patch. These channels allow small ions to equilibrate between the cell and the pipette allowing the cell to be voltage clamped through the open channels. Since substances as large as, or larger than, glucose will not permeate these channels, cell contents are not washed out as in standard whole-cell techniques. This is an advantage or a disadvantage, depending on the experiment. A distinct advantage is the maintenance of the intracellular environment that might influence conductances. With the perforated

patch technique, a rise in whole-cell capacity transients will be observed as the compound partitions into the cell, as shown in Figure 4.3. The Membrane Test feature of Clampex (v. 7 and higher) allows graphically monitoring the gradual rise in capacitance (and decrease in R_s) as pores are formed in the patch membrane.

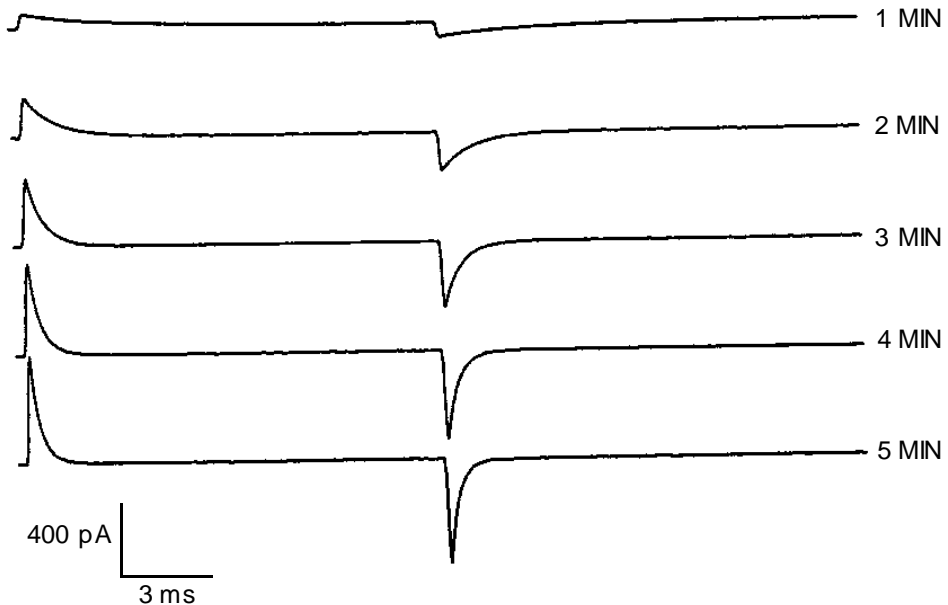

Figure 4.3. Going whole-cell: capacity transients observed during amphotericin partitioning.

Low Noise Techniques

The MultiClamp 700B is capable of producing stable, low-noise recordings. **To realize this performance the user must pay close attention to other sources of noise.** This is because the total rms noise of a patch clamp recording is the square root of the sum of the individual squared rms noise sources. This means that any particular noise source that is large will dominate the total noise and make other noise sources insignificant. Therefore, all potentially contributing noise sources must be minimized. Specifically, the headstage, the pipette glass, the holder, and

the seal contribute significantly even under circumstances where extraneous noise pickup from the environment is negligible. It is absolutely crucial that the entire preparation be properly shielded, and that hum from power supply, mains, and other sources be negligible, *i.e.*, $<0.1 \text{ pA}_{\text{p-p}}$. (Actually, $<0.01 \text{ pA}_{\text{p-p}}$ is possible with some effort.) In this section, we suggest some approaches to low-noise recording of single channels. While these same approaches are a good idea for whole-cell recording, they are less important since in whole-cell recording the dominant noise source comes from the access resistance in series with the whole-cell capacitance.

Glass Type and Coating

The noise from pipette glass itself arises from the lossy characteristics of its walls¹. Therefore, it is expected that glasses with the lowest inherent dielectric loss will have the lowest noise. Generally, the thicker the wall is, the lower the noise will be. These expectations have been largely borne out by actual experiments. Pipette glass can be obtained from specialty glass houses such as:

- **Clark Electromedical Instruments**
P.O. Box 8, Pangbourne, Reading, RG8 7HU, England, (073) 573-888
- **Garner Glass**
177 S. Indian Hill Road, Claremont, CA 91711, USA, (909) 624-5071
- **Jencons Scientific**
Cherycourt Way Industrial Estate, Stanbridge Road, Leighton Buzzard
LU7 8UA, UK, (0525) 372-010
- **Sutter Instrument Company**
51 Digital Drive, Novato, CA 94949, USA, (415) 883-0128

Each type of glass has unique advantages and disadvantages. Aluminosilicate glasses have lower loss factors, but are hard to pull because of their high

¹ When a sine voltage is applied across a perfect dielectric, the alternating current should be 90° out of phase with the voltage. The deviation from 90° is the "loss factor". The loss factor is related to the power dissipated in the dielectric. Since energy is lost in the dielectric, dielectrics (*e.g.*, glasses) are commonly referred to as "lossy".

softening temperature. High lead glasses are easier to pull, but have been reported to modify channel currents (*e.g.* see Cota and Armstrong, Furman and Tanaka, *Biophysical J.* 53:107-109, 1988; Furman and Tanaka, *Biophysical J.* 53:287-292, 1988). Since any glass may potentially modify channel currents, one must be aware of this fact and control for it regardless of the glass one uses. We recommend two glasses for noise-critical work: Corning #7052 and quartz. Both have been successfully sealed to many different cell types. Quartz, with its significantly lower loss factor, has produced the lowest noise recordings known to us. However, because of its extremely high-softening temperature, quartz requires a special puller like the P-2000 from the Sutter Instrument Company.

Even if one uses electrically superior glasses, low noise will not be obtained unless the outer surface of the glass is coated with a hydrophobic substance, such as Dow Corning Sylgard #184. This substance prevents the bathing solution from creeping up the outer wall of the pipette glass. This is important since a thin film of solution on the outer surface of the glass produces a distributed resistance that interacts with the glass capacitance to produce a noise source that rises with frequency. Since it becomes the dominant noise source, it must be eliminated. While many other hydrophobic substances have been used, none, to the best of our knowledge, produces as low noise as does Sylgard #184. Sylgard also decreases the capacitance of the pipette wall and so reduces the lossiness of the wall as well. It has been shown experimentally that Sylgard will improve the noise of any glass but it will not turn a poor electrical glass into a good one. Low-loss glasses coated with Sylgard give significantly less noise than poor glasses coated with Sylgard.

Obviously, the closer to the tip that the Sylgard can be applied, the lower the noise. However, under some conditions a thin film of Sylgard may flow right to the tip of the electrode, interfering with seal formation. This problem can be reduced by using partially-cured, thickened Sylgard for coating. Alternatively, or in addition, the tip of the electrode can be gently “polished” using a microforge to burn off the contaminating Sylgard.

Sylgard can be obtained from:

- **Dow Corning**
2200 Salzburg, Midland, Michigan 48611, USA, (517) 496-6000
- **K. R. Anderson**
2800 Bowers Avenue, Santa Clara, CA 95051, USA (800) 538-8712
- **UTSU SHOJI**
Tokyo, Japan (03) 3663-5581

Headstage

The noise of the current-to-voltage circuit in the headstage depends on the value of the feedback resistor. Larger feedback resistors generate less noise. (See Chapter 3, **TUTORIAL 3**; and Chapter 5, **FEEDBACK RESISTOR**.) The noise can be reduced still further by replacing the feedback resistor with a feedback capacitor, as is done in the integrating headstage circuit of the Axopatch 200B. This circuit was not used in the CV-7 headstage of the MultiClamp 700B (because of technical limitations with the digital circuitry). Therefore, for the most demanding low-noise applications it is recommended that an Axopatch 200B is used.

Electrode Holder

The holders supplied with the MultiClamp 700B are made of polycarbonate. Polycarbonate was experimentally found to produce the lowest noise among ten substances tested. It was only slightly better than polyethylene, polypropylene, and Teflon, but was much better than nylon, Plexiglass, and Delrin. Axon holders avoid metal and shielding, which are noise sources. Holders, however, do become a significant noise source if fluid gets into them. Therefore, great care must be taken in filling pipettes with solution. They should be filled only far enough from the tip so that the end of the internal chlorided silver wire or silver/silver chloride pellet is immersed. Any solution that gets near the back of the pipette should be dried with dry air or nitrogen to keep it from getting into the holder. Holders that become contaminated with solution should be

disassembled and sonicated in ethanol or pure deionized water, and allowed to dry thoroughly before being used again. It is also a good idea to periodically clean the holders by sonication even if no fluid has been observed in them.

Seal

The seal will usually be the dominant noise source if it is only a few gigohms. Seal resistances in excess of 20 G Ω must be obtained if exceptionally low noise single-channel recordings are to be routinely achieved. The noise depends also on the depth of the pipette tip below the surface of the bathing solution since the effective pipette capacitance increases as the depth of immersion increases. The voltage noise of the headstage interacts with the pipette capacitance to produce a noise source that rises with frequency. In order to minimize noise when recording from excised membrane patches, the electrode tip should be lifted until it is just under the surface of the bathing solution.

Signal Generator

One last potential noise source to consider is the noise in the signal generator that provides the command. In the MultiClamp 700B we have succeeded in minimizing this noise by heavily attenuating the external command. However, it is possible for this noise source to be significant, particularly if the command signal comes from a D/A converter.

Sharp Microelectrode Recording

The CV-7 headstage of the MultiClamp 700B contains both an Axopatch-like current-to-voltage converter and an Axoclamp-like voltage follower circuit. The former is activated when VC (V-Clamp) mode is selected in the MultiClamp 700B Commander, the latter when I=0 or IC (I-Clamp) mode is selected. Although the I-Clamp circuit is designed to be used with high-resistance sharp microelectrodes, it can also be used with lower-resistance patch electrodes, which in some cases offer advantages. (See next paragraph.) In this chapter it will be assumed for the most part that sharp microelectrodes are being used for the I-Clamp recording. However,

some of the general advice about I-Clamp recording applies equally well to patch electrodes.

Sharp Microelectrode or Patch Electrode?

The type and resistance of the electrode will depend on the particular application, and ultimately on personal preference, but there are a few points that should be considered.

Patch pipettes offer some advantages over intracellular micropipettes. First, the recording configuration is often more mechanically stable. Second, stable recordings can be obtained with patch pipette resistances one to two orders of magnitude lower than those of micropipettes.

This second point is most important and a number of benefits accrue. Due to its low resistance, a patch pipette used for voltage recording will have a better frequency response and lower noise level than a micropipette. Furthermore, the tip potential of high resistance intracellular micropipettes is often unstable and can change erratically as the cell is penetrated. In contrast, the tip (or junction) potential of patch pipettes is stable and can be accurately measured and corrected for electronically.

There are some instances where micropipettes may be more useful. If your study requires that the contents of the cell remain relatively intact (second messenger systems, for example), then patch pipettes may not be appropriate since the diffusible cellular components will eventually become diluted. In such cases you may wish to consider the “perforated patch” technique that prevents the loss of large intracellular molecules to the patch pipette (see Patch Clamping, above). Finally, for some cell types (*e.g.* those tightly wrapped in glial cells or connective tissue) it simply may not be possible to obtain gigaohm seals with patch electrodes.

Microelectrode Properties

Users of sharp microelectrodes spend far more time than patch clampers worrying about the properties of their electrodes. This is because the higher resistance of

sharp microelectrodes may introduce a number of undesirable properties. For best results, the microelectrode voltage must settle rapidly after a current pulse, and the microelectrode must be able to pass current without large changes in resistance.

The important factors that need to be considered are discussed below.

Electrode Glass

Borosilicate glass is often used; however, through trial and error one type of glass supplied by a specific glass manufacturer may have been shown to yield the best results. It is suggested that the literature be consulted prior to selecting glass for recording.

Tip Resistance

Tip resistance (R_e) should be as low as possible and consistent with good impalements of the cell. Low values of R_e allow for greater stability and faster settling time of the microelectrode.

Stability

R_e of most microelectrodes changes with time and with current passing. R_e is affected not only by the magnitude of the current but also by its polarity. In general, microelectrodes of lower resistance are more stable during current passing than those of higher resistance.

Settling time

The decay time constant of the microelectrode voltage after a current pulse depends strongly on R_e . Thus, lower R_e values produce faster settling times. As well, high R_e values are sometimes associated with a slow final decay even after the electrode capacitance has been eliminated. (See next page.)

Microelectrode Capacitance

The settling time of a microelectrode depends not only on R_e but also on the transmural capacitance (C_t) from the inside of the microelectrode to the external solution. For fastest settling, C_t must be as small as possible. C_t is usually 1-2 pF per mm of immersion. In order to reduce the effect of C_t , two approaches may be taken. One is to electronically compensate C_t using the Pipette Capacitance Neutralization control in the MultiClamp 700B Commander. This is discussed below, in the section on “Impaling Cells”. The other approach is to minimize the problem by careful experimental design, as follows.

In an isolated preparation, lowering the surface of the solution as far as possible can reduce C_t . For a long slender microelectrode, 200 μm or less is regarded as a low solution level; 500 μm is tolerable. Deep is regarded as 1 mm or more. For a microelectrode that tapers steeply (*i.e.* a stubby microelectrode) deeper solutions can be used with less loss of performance. When working with very low solution levels there is a risk of evaporation exposing the cells to the air unless a continuous flow of solution is provided across or through the preparation. If evaporation is a problem, try floating a layer of mineral oil on the surface of the solution. If used, this layer of oil will have the additional advantage of automatically coating the microelectrode as it is lowered into the solution.

Precautions must be taken to prevent surface tension effects from drawing a thin layer of solution up the outer wall of the microelectrode. If this film of saline is allowed to develop, C_t will increase substantially. Because the film of saline has axial resistance the contribution to C_t will be very nonlinear, and the voltage decay after a current pulse will either be biphasic or slow, even when capacitance neutralization is used. To prevent the saline film from developing, the microelectrode should be coated with a hydrophobic material. This can be done just before use by dipping the **filled** microelectrode into a fluid such as silicone oil or mineral oil. Another method is to coat the microelectrode with Sylgard #184 or Q-dope (model airplane glue). The selected material should be painted onto the electrode to within 100 μm of the tip.

Tip Potentials

During the passage of current, a slowly changing voltage may be generated at the tip of a microelectrode. Changes in this tip potential are indistinguishable from changes in the membrane potential and can therefore be a serious source of error.

Identifying Tip Potentials

- While the microelectrode is outside the cell, press the Pipette Offset button to zero the offset. In IC mode, pass a constant current into the bath for about 10 seconds; this can be done by setting a Holding current in the MultiClamp 700B Commander and checking the Holding checkbox. The current magnitude should be the same as the maximum sustained current likely to be passed during the experiment. When the current is switched off the recorded potential should return to zero within a few milliseconds at most. Some microelectrodes either return very slowly to zero potential, or not at all. These micropipettes should be discarded.
- While the experiment is in progress, occasionally check the resistance of the microelectrode. Changes in tip potential are usually accompanied by changes in microelectrode resistance.

Preventing Tip Potentials

Not much can be done to prevent tip potentials from changing but the following may be helpful.

- Sometimes the slow changes in tip potentials are worse when a AgCl pellet is used instead of a Ag/AgCl wire. Some holders are acceptable while other, ostensibly identical, holders are not. Therefore holders should be tested and selected.
- The variability of the tip potentials may be related to pressure developed when the microelectrode is pressed into an unvented holder.

The suction port on the HL-U series holders provided with the MultiClamp 700B should therefore be left open.

- Using filling solutions with low pH, or adding small concentrations of polyvalent cations like Th^{4+} , may reduce the size of the tip potential and therefore the magnitude of any changes (Purves, 1981).

Filling Solutions

The best filling solution to use depends on the preparation under investigation and the experience of the investigator. Although KCl gives one of the lowest tip resistances for a given tip diameter, a KCl-filled electrode is not necessarily the fastest to settle after a current pulse. K-citrate is sometimes faster.

It is important to be aware that during current-passing, large amounts of ions from inside the microelectrode can be ionophoresed into the cell. For example, if current is passed by the flow of ion species A from the microelectrode into the cell, then after 50 seconds of current at 1 nA (or 1 s of current at 50 nA) the change in concentration of A inside a cell 100 μm in diameter is 1 mM. If A is an impermeant ion, the cell may swell due to the inflow of water to balance the osmotic pressure. The injection of a permeant ion, such as chloride, can significantly alter the equilibrium potential for that ion.

Impaling Cells

Start with the MultiClamp 700B in IC mode (I-Clamp). Fill a microelectrode with internal solution and secure it firmly in the pipette holder. Be sure to support the headstage with your other hand so that the micromanipulator will not have to absorb your force. Advance the electrode until its tip enters the bath. Press the Pipette Offset button to null the offset.

Note: Check the stability of the bath electrode and microelectrode. Drifts in Primary output: Membrane Potential indicates that the electrode wires probably need to be rechlorided. Also check for a changing tip potential by passing a steady current, as described above.

Check the Tuning checkbox and observe the Primary Output: Membrane Potential on a scope. Move the electrode tip close to where cells are likely to be encountered, and then increase Pipette Capacitance Neutralization in the MultiClamp 700B Commander to give the fastest step response. It is advisable to adjust the capacitance neutralization with the microelectrode as close as possible to the final position, since moving the electrode can change C_t and invalidate the setting. It may be wise to slightly under-compensate, because changes in the solution level could lead to oscillations that may destroy the cell.

Press the Bridge Balance button. The value ($M\Omega$) found for optimal balance gives the resistance of the electrode. See Chapter 5, **BRIDGE BALANCE**, for further details.

Sometimes the cell is impaled as soon as the microelectrode is pressed against the cell surface. More often the microelectrode is advanced until there is a slight deflection in the tip potential. At this point the cell can be impaled by pressing the Buzz button or the Clear +/Clear - buttons. If these fail, vibrating the microelectrode tip by lightly tapping on the micromanipulator sometimes works. When the electrode penetrates the cell there is a sudden change in the Membrane Potential trace, reflecting the intracellular potential. The voltage response to the Tuning steps will be slower and much larger, reflecting the membrane time constant and input resistance. After impaling the cell, it is often helpful to back off the microelectrode slightly and allow the penetration to stabilize for a few minutes. For some cells it may help to apply a small DC current to the electrode (enough to produce several mV hyperpolarization) during the penetration. Selecting the Holding checkbox and slowly increasing the Holding value can apply this DC current.

Once the penetration has stabilized, you should recheck the Bridge Balance and Pipette Capacitance Neutralization. Further details on this are given in Chapter 5. It is sometimes useful to inject a small, brief current pulse at the start of each sweep of data collection in order to continually check the Bridge Balance setting during the course of an experiment.

Chapter 5

Reference Section

It is expected that the MultiClamp 700B Commander On-line Help will answer many questions about the operation of the MultiClamp 700B. This chapter provides details of the theory and operation of the MultiClamp 700B, beyond what is available in the On-line Help. The information in this section is gathered under a number of broad topics, arranged in alphabetical order. Because the MultiClamp 700B is effectively two instruments in one (an Axopatch-1D and an Axoclamp 2B), the topics are sometimes divided into two sections, or refer to only voltage clamp or current clamp mode.

Please consult the Index if you are having trouble locating a particular item.

Note: Before using this chapter, it may be helpful to first read the entry under “Polarity Conventions”. This summarizes the conventions used for the polarities of currents and voltages in all amplifiers manufactured by Axon Instruments.

Audio Monitor

- Used for audio monitoring of an electrical signal.
- The Audio control panel is accessed via the toolbar button .

The Audio Monitor provides auditory feedback for a user-selectable signal (Membrane Current or Potential on Channel 1 or 2). This is sometimes useful while attempting to seal onto or impale a cell, since it obviates the need to look at an oscilloscope while manipulating the electrode.

One of two Audio Modes can be selected.

- Direct Signal Monitoring. The selected signal is relayed directly to the output speaker. This mode is especially useful for monitoring spikes, which are heard as audible clicks.
- Voltage Controlled Oscillator (VCO). The voltage of the signal determines the frequency of a sine wave that is then directed to the output speaker. This is useful if the signal of interest is a DC signal, *e.g.* the membrane potential. The default setting for the VCO is 2200 Hz at 0 V ranging to 300 Hz at -100 mV.

Audio output can be monitored by making connections to the MultiClamp 700B in one of three different ways:

1. Connect the rear panel AUDIO OUTPUT to the Line IN connector of your computer sound card. This allows the MultiClamp 700B to use the computer's speaker.

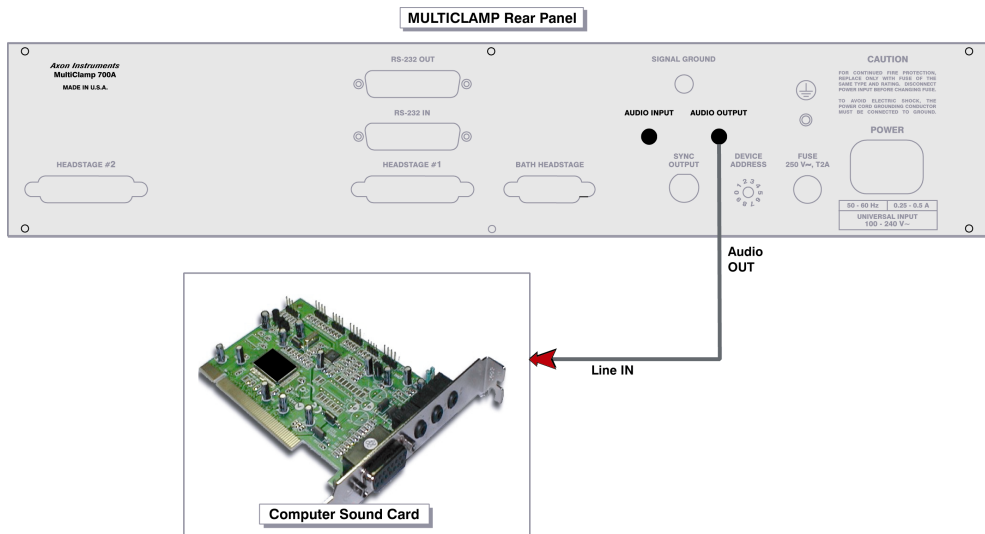

Figure 5.1. Possible Audio configuration #1.

2. Connect headphones or remote powered speakers to the front panel PHONES output or the rear panel AUDIO OUTPUT. This allows dedicated use of the headphones or external speakers by the MultiClamp 700B.

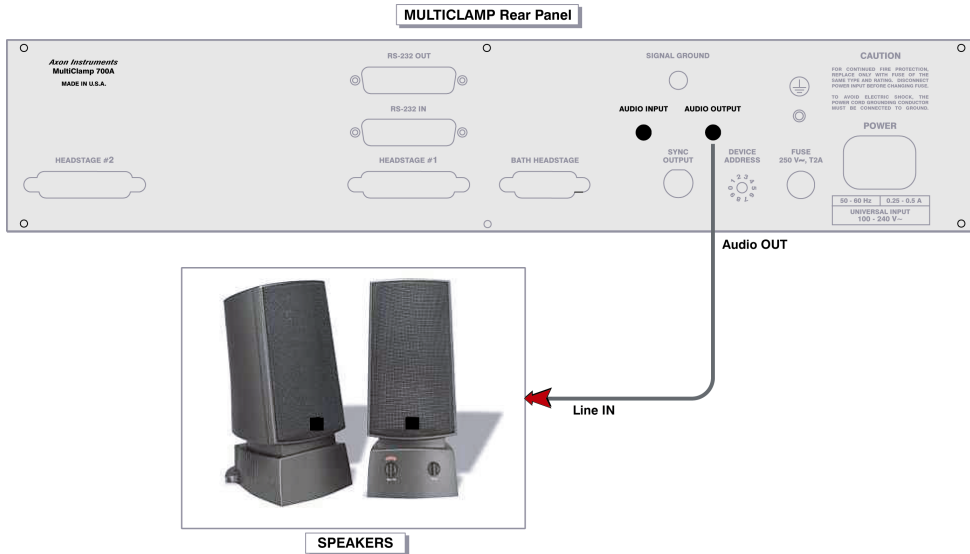

Figure 5.2. Possible Audio configuration #2.

3. Connect the Line OUT of your computer sound card to the rear panel AUDIO INPUT of the MultiClamp 700B, and the rear panel AUDIO OUTPUT to external powered speakers. This is the same as option 2, except that now the MultiClamp 700B audio output is mixed with the computer's audio output to external speakers.

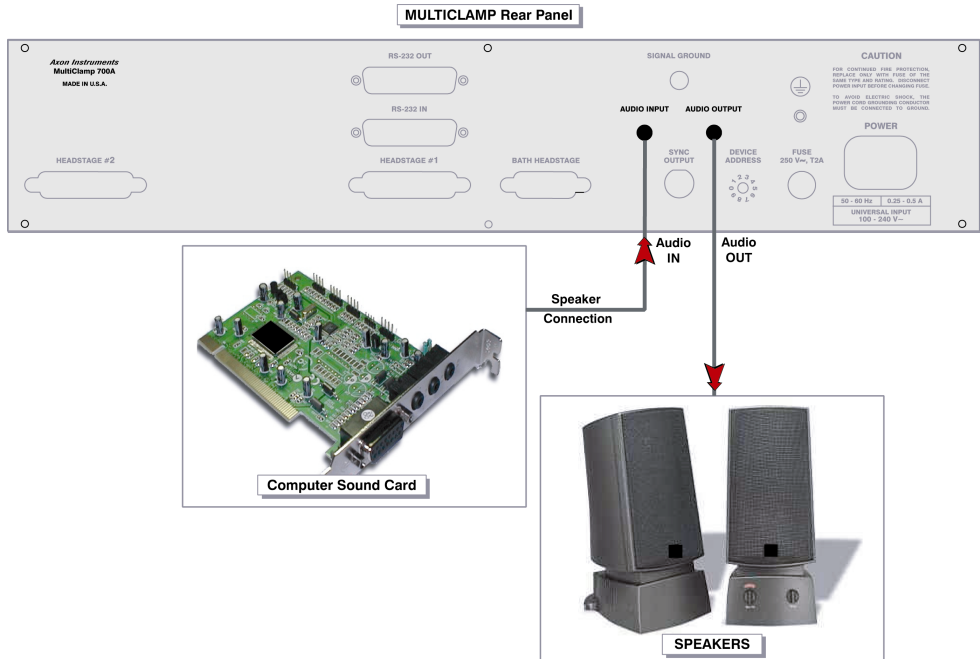

Figure 5.3. Possible Audio configuration #3.

WARNING: Never connect the computer's microphone jack to Audio connectors on the MultiClamp 700B. This could lead to large voltages being sent to the MultiClamp 700B, with the possibility of causing damage to its circuitry.

Bath Headstage and Electrodes

The Bath Headstage is used when recording from cells with a large conductance, in order to minimize errors due to current flow through the bath electrode. The VG-2 series Bath Headstage is optional hardware that can be used with the MultiClamp 700B for this purpose.

In most experiments, the bathing solution is grounded by a solid grounding electrode (such as an agar/KCl bridge) and all measurements are made relative to the system ground (on the assumption that the bath is also at ground). This assumption may not be true if the Cl^- concentration or the temperature of the bathing solution is significantly changed, if there is restricted access from the extracellular space to the grounding point, or if the membrane current is sufficiently large as to cause a significant voltage drop across the resistance of the grounding electrode. The latter circumstance, which normally arises only when voltage clamping large cells with large membrane currents, is the situation for which the bath headstage is intended.

In a simple voltage clamp setup, the voltage drop across the resistance of the bath grounding electrode (R_b) is indistinguishable from the membrane potential. That is, the potential recorded by the microelectrode is the sum of the transmembrane potential (V_m) and the voltage drop across R_b . Problems arise if the product of the clamp current (I) and R_b is significant. For example, for $I = 5 \mu\text{A}$ and $R_b = 2 \text{k}\Omega$, the voltage error is 10 mV.

To minimize this problem with the MultiClamp 700B, the following two strategies can be adopted.

R_b Minimization

There are three main contributors to R_b :

- The cell access resistance from the membrane surface to the bath
- The resistance of the grounding pellet

- The resistance of the agar bridge (if used)

Typical values of the access resistance of a 1 mm diameter sphere in Ringer's solution (such as an oocyte) are on the order of 150-200 Ω . This is a given, and no amount of manipulation can alter this for a given set of experimental conditions; fortunately it is relatively small. On the other hand, the combined resistance of the grounding pellet and agar bridge are larger, but one can take precautions to minimize them. A 1 mm diameter Ag/AgCl pellet in Ringer's solution has a resistance of 300-600 Ω , depending on how much of the surface is in contact with the saline. The larger the surface area in contact with the saline, the smaller the resistance.

The resistance of an agar bridge depends on the length and diameter of the bridge, as well as its contents (*i.e.* Ringer's Solution *versus* 3 M KCl). For a 1 cm long bridge:

| | 1 mm diameter | 2 mm diameter |
|-----------------|----------------------|----------------------|
| Ringer's | 10.2 k Ω | 2.6 k Ω |
| 3 M KCl | 510 Ω | 130 Ω |

Therefore, to minimize R_b , it would be best to eliminate the agar bridge and ground the preparation directly with a Ag/AgCl pellet. The pellet should be as large as practical, and the area of it in contact with the solution should be maximized. With this kind of bath electrode, you should avoid perfusing the bath with solutions containing different chloride activities. The DC offset of an Ag/AgCl pellet changes with chloride activity.

In order to minimize R_b when using an agar bridge, it is best to fill the bridge with 3 M KCl instead of Ringer's solution. When the agar bridge is filled with 3 M KCl, the sum of all components of R_b will be approximately 1-2 k Ω . If leakage of KCl from the agar bridge is a problem, it may be necessary to fill the agar bridge with Ringer. In this case, R_b will be several kilohms.

Use of a Bath Headstage

Another method for minimizing the effect of the voltage drop across R_b is to actively control the bath potential, measured near the outside surface of the cell. This is achieved using a virtual-ground circuit, the bath headstage.

The MultiClamp 700B is compatible with one of the following bath headstages from Axon Instruments: VG-2-x0.1 and VG-2A-x100. These headstages attach to the MultiClamp 700B via the rear-panel 15-pin D connector.

The basic design of both types of headstage is illustrated in Figure 5.4.

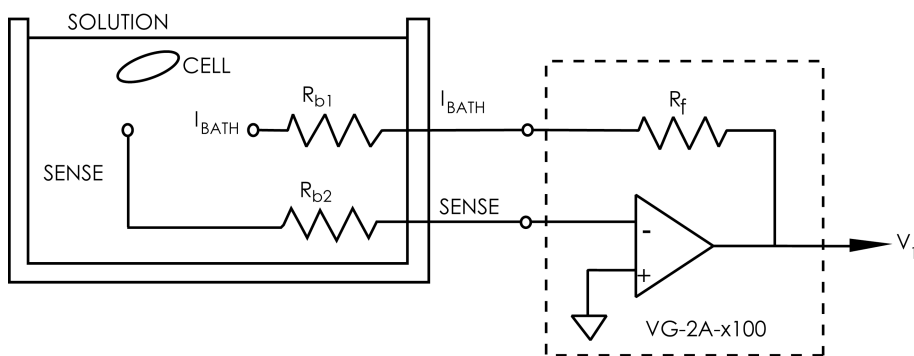

Figure 5.4. Bath headstage.

One electrode (SENSE) is a voltage-sensing electrode. It is placed in the bath near the cell surface. It is connected to the virtual-ground circuit by an agar bridge or similar, of resistance R_{b2} . Since there is no current flowing through this electrode, there is no voltage drop across R_{b2} . The other electrode (I_{BATH}), with resistance R_{b1} , is also placed in the bath. This electrode carries the ionic current. The feedback action of the operational amplifier ensures that the potential at the SENSE electrode is equal to the potential at the positive input, *i.e.* 0 mV, irrespective of the voltage drop across R_{b1} .

Bridge Balance

- Used to subtract voltage drops across the microelectrode when in I-Clamp mode.
- Bridge balance is activated by pressing the button in the Bridge Balance box in the I-Clamp pane or by checking the checkbox and using manual glider control.
- See also Capacitance Neutralization.

In some experiments it may be desired to inject a current (I) into a cell in current-clamp mode, *e.g.* to depolarize the cell and evoke action potentials. The flow of I through the microelectrode produces a voltage drop across the electrode that depends on the product of I and the microelectrode resistance (R_e). This unwanted IR_e voltage drop adds to the recorded potential. The Bridge Balance control can be used to balance out this voltage drop so that only the membrane potential is recorded. The term “Bridge” refers to the original Wheatstone Bridge circuit used to balance the IR voltage drop and is retained by tradition, even though operational amplifiers have replaced the original circuitry.

The technique is illustrated schematically in Figure 5.5A. A differential amplifier is used to subtract a scaled fraction of the current I from the voltage recorded at the back of the microelectrode, V_p . The scaling factor is the microelectrode resistance (R_e). The result of this subtraction is thus the true membrane potential, V_m .

Figure 5.5B shows how bridge balance is done in practice. When the current is stepped to a new value (top), there is a rapid voltage step on V_p due to the ohmic voltage drop across the microelectrode (middle). Following this instantaneous step, there is a slower rise in V_p largely due to the membrane time constant of the cell. Correct adjustment of the bridge amplifier removes the instantaneous step, leaving the corrected V_m trace (bottom). Although this adjustment is done with a step current injection, the correction remains valid for any arbitrary waveform of injected current, provided the microelectrode maintains a constant resistance.

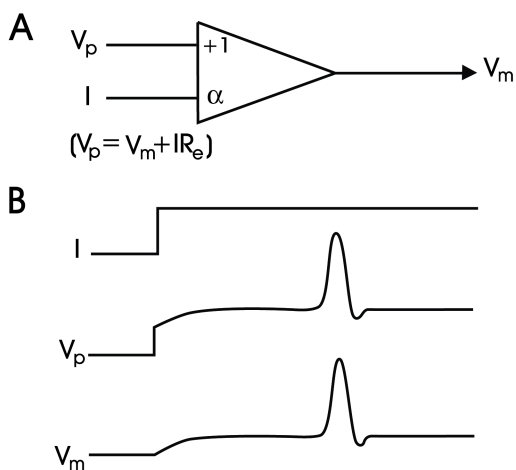

Figure 5.5. Schematic bridge balance circuit and adjustment procedure.

Bridge Balance in the Bath

Some investigators like to set Bridge Balance in the bath, before attempting to impale cells. This is to make it easier to see when a cell has been penetrated.

Check the Tuning checkbox and set the parameters to -1 nA and 50 Hz. Observe the Membrane Potential on Primary Output. Press the Auto Bridge Balance button; the fast voltage steps seen at the start and finish of the current step should be

eliminated. You may need to manually adjust the Bridge Balance $M\Omega$ value for optimum balance. The $M\Omega$ value is the resistance of the electrode.

Bridge Balance in the Cell

The Bridge Balance should be frequently checked when inside a cell, because the electrode resistance can drift. While setting Bridge Balance, Pipette Capacitance Neutralization should also be set. (See Capacitance Neutralization.) Both settings can be monitored continuously through the experiment by injecting a small current step near the beginning of each data sweep.

It is recommended that Pipette Capacitance Neutralization be set at the same time as Bridge Balance, because both the electrode capacitance and the electrode resistance cause errors if left uncompensated. Also, it is easier to correctly balance the bridge when electrode capacitance is minimized, because the “break” between the rapidly decaying voltage across the microelectrode and the slowly decaying voltage across the cell’s membrane resistance is more distinct.

The balancing procedure is the same as in the bath, except that the trace appears more rounded because of the time constant of the cell membrane. Because the Tuning pulse width is typically brief compared with the membrane time constant, the voltage response looks like a series of ramping straight lines. To make it easier to see the fast voltage step in V_p on an oscilloscope (Figure 5.5B), it is recommended that the scope input be AC coupled to remove the resting membrane potential from the signal. The scope gain can then be turned up without the annoying offset. The $M\Omega$ value found by Bridge Balance is the resistance of the electrode, which may be slightly higher than the value in the bath because of partial blockage of the tip during penetration.

The residual transient at the start and finish of the current step is due to the finite response speed of the microelectrode, which is determined in part by the capacitance of the electrode. The transient can be minimized by correctly setting the Pipette Capacitance Neutralization control. (See Capacitance Neutralization.) Adjust Pipette Capacitance Neutralization for the most rapid decay without causing an overshoot. (See Figure 3.27, Chapter 3.)

Buzz

- Used as an aid for cell impalement or for clearing electrodes.
- Buzz is activated by pressing the **Buzz** button in the I-Clamp pane.
- See also Clear.

Buzz works by briefly applying a 15 V_{p-p} 10 kHz filtered square wave to the neutralization capacitor.

Depending on the microelectrode and the preparation, this method can aid in clearing blocked electrode tips. When used while the tip of the microelectrode is pressing against the membrane, Buzz may also cause the micropipette to penetrate the cell. The exact mechanism is unknown, but it may involve attraction between the charge at the tip of the electrode and bound charges on the inside of the membrane.

The duration of the Buzz oscillation is set by the user (50 μs-500 ms). The frequency of the oscillation is 10 kHz. For some small cells a long duration Buzz can be deadly. An appropriate duration can be found for most cells that is sufficiently long to allow penetration of the membrane but short enough that the cell is not damaged after penetration.

Capacitance Compensation

- Used to compensate electrode and cell capacitance when in V-Clamp mode.
- Electrode capacitance is compensated using the **Cp Fast:** **Cp Slow:** controls in the V-Clamp pane.
- Cell capacitance is compensated by checking the **Whole Cell** checkbox and using the associated controls in the V-Clamp pane.
- See also External Command Inputs, Series Resistance Compensation.

Electrode Capacitance Compensation

When a voltage-clamp step is applied to an electrode, the clamp must provide a spike of current at the start (and finish) of the step to charge (and discharge) the capacitance of the electrode (C_p). The main problem with these spikes is that they may saturate the headstage circuit or later circuits, leading to distortion of the signals of interest. Injecting into the input of the headstage a current that directly charges the electrode capacitance, bypassing the normal voltage clamp circuitry, solves this problem. Thus, when the compensation is correctly adjusted, the charge

The MultiClamp 700B Commander provides two electrode compensation controls, and discharge of the electrode capacitance is invisible to the user.

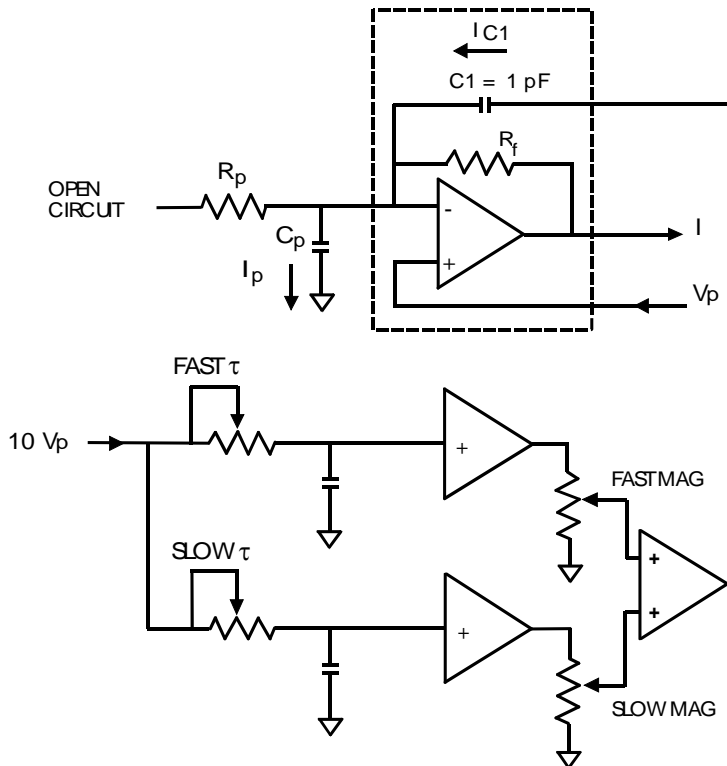

Figure 5.6. Pipette capacitance compensation circuit.

C_p Fast and C_p Slow. C_p Fast compensates that part of the electrode capacitance that can be represented by a lumped capacitance at the headstage input. This is the major part of C_p. A small amount of C_p can only be represented as a capacitor with a series resistance component. This takes longer to charge to its final value and is compensated by the C_p Slow controls.

A simplified description of the fast and slow compensation circuitry is shown in Figure 5.6. When the pipette command potential (V_p) changes, current I_p flows into C_p to charge it to the new potential. If no compensation is used, I_p is supplied by the feedback element (R_f) resulting in a large transient signal on the output (I). By properly setting the fast and slow magnitude and τ controls, a current (I_{C1}) can be induced in capacitor C1 (connected to the headstage input) to exactly equal I_p . In this case R_f needs to supply no current and there is no transient on the output.

Whole-Cell Capacitance Compensation

When in whole-cell mode, a voltage-clamp step must charge not only the electrode capacitance, but also the capacitance of the cell (C_m). The decay time constant of the whole-cell capacitance transient is determined by the product of C_m and the resistance in series (R_s) with C_m . If R_s and C_m are both reasonably large, the resultant capacitance transient can last for several milliseconds, perhaps distorting the rising phase of biologically interesting currents. Furthermore, as in the case of the electrode capacitance transient, the whole-cell transient may saturate the circuitry of the MultiClamp 700B or downstream instruments if left uncompensated. Finally, whole-cell capacitance compensation is necessary for series resistance compensation. For all of these reasons, it is desirable to electronically compensate the capacitance of the cell.

Like electrode capacitance compensation, whole-cell compensation uses a circuit to inject current directly into the input of the headstage. Figure 5.7 shows a simplified schematic of this circuit.

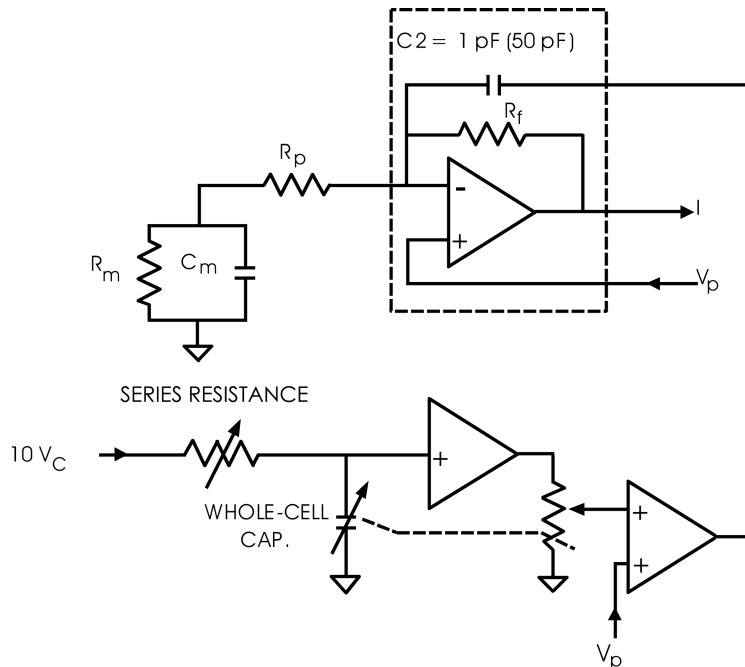

Figure 5.7. Whole-cell capacitance compensation circuit.

Assume that the fast and slow electrode compensation controls have already been set to compensate for C_p . By appropriately adjusting the SERIES RESISTANCE and WHOLE CELL CAP values in this circuit, the current injected through C_2 will supply the transient membrane current (I). These adjustments do not alter the time constant for charging the membrane. Their function is to offload the burden of this task from the feedback resistor, R_f . In many cells, even a small command voltage (V_c) of a few tens of millivolts can require such a large current to charge the membrane that it cannot be supplied by R_f . The headstage output saturates for a few hundred microseconds or a few milliseconds, thus extending the total time

necessary to charge the membrane. This saturation problem is eliminated by appropriate adjustment of whole-cell capacitance compensation. This adjustment is particularly important during series resistance correction since it increases the current-passing demands on R_f . By moving the pathway for charging the membrane capacitance from R_f to C_2 , the series resistance compensation circuitry can operate without causing the headstage input to saturate. (See also Chapter 5, **SERIES RESISTANCE COMPENSATION**.)

The effect of transferring the current-passing burden from R_f to C_2 is illustrated in Figure 5.8.

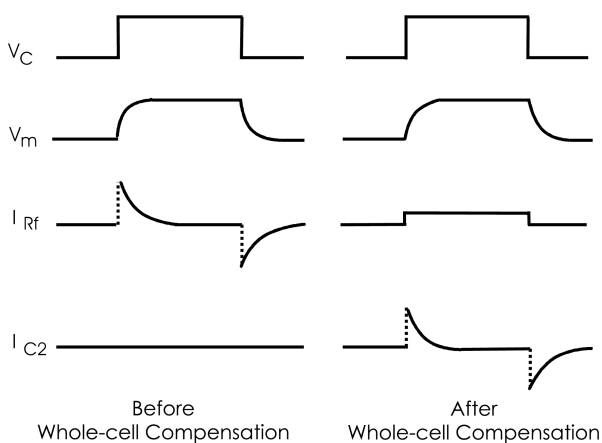

Figure 5.8. Using the injection capacitor to charge the membrane capacitance.

After perfect whole-cell compensation is applied, the current to charge the membrane capacitor is removed from the I_{Rf} trace and only the steady state current remains. All of the transient current appears in the I_{C2} trace. (The I_{C2} trace in the figure was recorded using an oscilloscope probe connected to the internal circuitry). The Membrane Current and Command Potential outputs on the MultiClamp 700B would look like the I_{Rf} and V_C traces, respectively (Figure 5.8). It is easy to mistakenly think that the time course for charging the membrane is very fast but

this is clearly not the case. Use of an independent electrode in the cell would show that the cell charging rate is not affected by these adjustments.

The pF and M Ω values found by the MultiClamp 700B Commander for optimal whole cell compensation provide estimates of the cell capacitance and the series resistance, respectively. However, these estimates are accurate only if the cell input resistance is significantly greater than R_s .

Auto Button

When the Auto button is pressed to automatically compensate C_p or Whole Cell capacitance, the MultiClamp 700B Commander applies a series of brief voltage pulses to the electrode and uses the Membrane Current response to optimize the compensation. The parameters used in this optimization can be set in the Options/Advanced pane. We recommend setting the pulse amplitude to be as large as possible without causing damage to the cell. The amplitude can be positive or negative (default is -50 mV).

The Whole Cell Window Width is the duration of the window (in multiples of Tau, the fitted time constant of the whole cell transient) over which the algorithm optimizes whole cell compensation. The best setting depends on the cell type and is best found by trial and error. As a general rule of thumb, 1 x Tau works best for large cells with a highly distributed capacitance and 10 x Tau works best for small, compact cells (default 8 x Tau).

Manual Adjustment of Capacitance Compensation

Although the algorithm used by the Auto button is reasonably robust, and is likely to work under most circumstances, it may sometimes be necessary to manually adjust the C_p Fast/Slow or Whole Cell compensation. This is done by using the dual controls, , or by entering values directly. It is recommended that you practice using these controls with the PATCH-1U model cell. The best strategy is to first set the capacitance (pF) value to roughly what is expected (*i.e.* ~ 5 pF for electrode capacitance, ~ 30 - 100 pF for whole-cell capacitance) and then to adjust the time constant (μ s) or resistance (M Ω) values, respectively, for optimal

compensation. After these approximate values have been established, iterative adjustment using  becomes easier.

Filtering the Command Stimulus

Under some conditions, such as when very large voltage clamp steps are applied, the capacitance transients cannot be fully compensated and the amplifier may still saturate. Under these conditions it may be helpful to reduce the size of the capacitance transient by slowing down the voltage clamp command step. This can be achieved by filtering the command stimulus before it is applied to the cell. This filtering can be done within the MultiClamp 700B. (See Chapter 5, **EXTERNAL COMMAND INPUTS**.)

Capacitance Neutralization

- Used to partially cancel the effects of microelectrode capacitance in I-Clamp mode.
- This control is adjusted in the  Pipette Capacitance Neutralization: field in the I-Clamp pane.
- See also Bridge Balance.

Input Capacitance

The capacitance (C_{in}) at the input of the headstage amplifier is due to the capacitance of the amplifier input itself (C_{in1}) plus the capacitance to ground of the microelectrode and any connecting lead (C_{in2}). C_{in} combined with the microelectrode resistance (R_e) acts as a low-pass filter for signals recorded at the tip of the microelectrode. For optimal performance at high frequencies this RC time constant must be made as small as possible.

Two techniques may be used to increase the recording bandwidth.

- Use microelectrodes with the lowest possible resistance compatible with stable recording, and take steps to minimize the contribution to C_{in} by the capacitance

of the microelectrode. In practice, this means using patch electrodes where possible, or using sharp microelectrodes with minimal capacitance. (See Chapter 4, **SHARP MICROELECTRODE RECORDING**).

- Electronically neutralize C_{in} .

The second approach has been implemented in the MultiClamp 700B in two ways.

Primary Method for Neutralizing C_{in}

A special technique is used in the CV-7 headstage to keep the contribution to C_{in} from the input amplifier as small as possible. The technique is known as “bootstrapping”. Unity gain feedback is used to reduce the component of stray capacitance that exists between the amplifier input and its power supplies and case. Sophisticated circuitry is used to superimpose the unity-gain output of the buffer amplifier back onto its own power supplies and the headstage case, fixing the voltage drop across C_{in1} to a constant value, thereby preventing current flow through C_{in1} . The effective value of C_{in1} is thus reduced to well below its real value. This eliminates the high-frequency current loss through the power supply capacitance, thereby increasing the bandwidth. Since the power supply capacitance is present whether or not the power supply is bootstrapped, there is no noise penalty due to implementing this technique.

Secondary Method for Neutralizing C_{in}

In some cases the steps discussed above may not be sufficient to decrease the RC time constant of the voltage-recording microelectrode, particularly in situations where high resistance microelectrodes must be used. For this reason an effective, though less desirable, technique is provided that can electrically reduce the *effective* magnitude of C_{in2} . The technique is known as “capacitance compensation”, “negative capacitance” or “capacitance neutralization”. A compensation amplifier at the output of the unity gain buffer drives a current injection capacitor connected to the input. At the ideal setting of the compensation-amplifier gain, the current injected by the injection capacitor is exactly equal to the current that passes through C_{in2} to ground.

Adjusting Capacitance Neutralization

Check the Tuning checkbox and choose amplitude (nA) and frequency (Hz) parameters that result in a sawtooth pattern of about 10 mV amplitude on “Primary Output: Membrane Potential”. Carefully increase the Pipette Capacitance Neutralization value until overshoot just starts to appear in the step response. This is easiest to see if you have already adjusted Bridge Balance. (See Chapter 5, **BRIDGE BALANCE**.) If you go too far the overshoot may become a damped oscillation, which may escalate into a continuous oscillation, killing the cell.

Sometimes the overshoot is difficult to see. In this case, you may prefer to look at the “Primary Output: Membrane Potential” trace at high gain on an oscilloscope, advancing the Pipette Capacitance Neutralization value until the trace becomes noisy and oscillations seem imminent. It is usually prudent to reduce the Pipette Capacitance Neutralization setting slightly from the optimal, in case the capacitance changes during the experiment.

Limitations of Capacitance Neutralization

Use of capacitance neutralization is less desirable than physically minimizing C_{in2} , since the neutralizing circuit adds noise to the voltage signal. This noise has been minimized in the CV-7 headstage of the MultiClamp 700B by using low-noise amplifiers and small injection capacitors, but it is still significant.

It is important to recognize that the capacitance neutralization circuit is not more than 90% effective even for ideal microelectrodes. This is because of the finite frequency responses of the headstage amplifiers and the capacitance neutralization circuit, and also because C_{in2} does not behave ideally as a linear lumped capacitor. Consequently, the amount of C_{in2} that the circuit must neutralize should be kept as small as possible. (See Chapter 4, **SHARP MICROELECTRODE RECORDING**.)

Clear

- Used to clear blocked microelectrodes and to assist in impaling cells in I-Clamp mode.
- Clear is operated by alternately pressing the **Clear +** and **Clear -** buttons in the I-Clamp pane.
- See also Buzz.

Clear is used to pass large amounts of current down the microelectrode. Plus (+) and minus (-) correspond to depolarizing and hyperpolarizing currents, respectively. Clear is used for two purposes:

- Clearing blocked microelectrodes. If the microelectrode resistance in the bath seems much higher than it should be, the electrode can often be cleared by rapidly toggling the Clear switch from plus to minus. Because of the large current passed this should only be done extracellularly.
- Penetrating cells. Sometimes microelectrode tips press against the cell membrane but fail to penetrate. A quick press on the Clear buttons will often force the electrode to penetrate. Whether to use a hyperpolarizing or depolarizing current depends on the preparation and must be determined by trial and error. Like Buzz, the mechanism for impalement is unknown.

Electrochemistry

- Using the MultiClamp 700B for electrochemistry.
- See also electrochemistry application notes under ‘Technical Support’ at <http://www.axon.com>

Electrochemistry, with the meaning intended here, is the use of an electrochemical sensor to record signals that reflect the presence of electro-active chemicals in biological tissue. For biological applications, the sensor is typically a carbon-fiber microelectrode. Examples of electro-active biological chemicals are dopamine and

norepinephrine. The MultiClamp 700B, like the Axopatch 200B, can be used to measure the electrical signals generated by the presence of these chemicals.

To make electrochemical measurements, a voltage is typically applied to the sensor. This results in the oxidation or reduction of the electro-active species in solution near the tip of the sensor. The current that is derived from the measurement is a complex combination of chemical kinetics and molecular diffusion that is relatively specific for different chemical classes of compounds. In short, the technique generates a chemical fingerprint for each compound of interest. Furthermore, the current that is derived from the oxidation (or reduction) of these compounds is directly proportional to the concentration.



Two methods are used for making electrochemical measurements, cyclic voltammetry and amperometry.

Cyclic voltammetry typically involves applying an episodic voltage ramp to the sensor while the resultant current is measured under voltage clamp. The potential at which dopamine (and other catechol-containing species such as epinephrine and norepinephrine) oxidizes is approximately 0.15 V *cf.* the silver/silver chloride reference potential. In order to accurately measure the voltammetric response of dopamine in solution, the sensor is poised at a reducing potential between measurements and ramped to more oxidizing potentials to generate the electrochemical fingerprint. In a typical experiment, the ramp may last 100 ms; this, then, is the resolution of the measurement. Cyclic voltammetry is most often used to make relatively slow, volume-averaged measurements of the concentrations of electro-active compounds.

Amperometry involves voltage clamping the sensor at the oxidation/reduction potential of the compound of interest while measuring the resultant current. Sudden changes in the concentration of the compound are registered as blips of current. Amperometry is typically used for measuring quantal release of electro-active chemicals from vesicles. The temporal resolution is determined only by the response times of the sensor and the voltage clamp.

Both cyclic voltammetry and amperometry can be performed by the MultiClamp 700B without modifications. Such modifications are necessary for some other Axon amplifiers because electrochemistry typically requires larger voltage commands than is usual for patch or intracellular recording. However, the MultiClamp 700B was designed with these larger commands in mind, providing ± 1000 mV range.

External Command Inputs

- External command stimuli are applied to the COMMAND BNC on the front panel of the MultiClamp 700B.
- External Command Sensitivity is set in the Gains tab under the Options button .
- Command Filter Frequency is set in the General tab under .
- See also Capacitance Compensation, Feedback Resistor, Filter, and Mode.

Although the MultiClamp 700B Commander provides some simple built-in command stimuli (*e.g.* via the Pulse button), it is expected that most experiments will require more complex stimulus protocols. These must be supplied by an external pulse generator or a computer program like pCLAMP. External stimulus commands are supplied to the MultiClamp 700B via the COMMAND BNC on the front panel (one BNC for each Channel). Note that this is a DC-coupled input, so be sure that the external pulse generator is correctly calibrated so that zero volts really correspond to zero.

External Command Sensitivity

External Command Sensitivity is a scaling parameter that is set in the Gains tab under the Options button.

In V-Clamp mode, the purpose of External Command Sensitivity is to scale down the command signal in order to reduce the effect of noise in the external pulse

generator. There are three settings: 20 mV/V, 100 mV/V and OFF. For example, 20 mV/V means that a 1 Volt step applied to the COMMAND BNC will appear to the cell as a 20 mV step; *i.e.* external commands are divided down by 50-fold. This setting should be used when you wish to minimize noise as much as possible. The 100 mV/V setting (10-fold dividing down) should be used when you wish to apply larger command stimuli to the cell and noise is less of a concern.

In I-Clamp mode, the purpose of External Command Sensitivity is to scale a voltage COMMAND signal into current. For example, 0.4 nA/V means that a 1 Volt step applied to the COMMAND BNC will appear to the cell as a 0.4 nA step injection of current. The three Sensitivity settings change as the value of the Current Clamp Feedback Resistor is changed, since the amount of current that can be injected by the headstage depends on this resistor. (The maximum current possible with each resistor is listed in the Gains tab under Current Clamp.)

Additivity of Commands

All command stimuli applied by the MultiClamp 700B are additive. That is, the external command is algebraically added to Holding, Pulse and Seal Test or Tuning commands before the sum is applied to the cell.

Command Filter Frequency

Prior to being applied to the cell, the summed commands can be low-pass filtered at a selectable frequency. The Command Filter Frequency is set in the General tab under the Options button. The selectable frequency is the -3 dB cutoff frequency of a 4-pole Bessel filter. Two filter settings are provided for each Channel, one for V-Clamp, the other for I-Clamp.

This feature is provided because sometimes is desirable to round off the commands applied to a cell. For example, a large voltage step in V-Clamp mode may produce a large capacitance transient that cannot be fully compensated by Capacitance Compensation and which still saturates the amplifier. Lightly filtering the command signal solves this problem by slowing down the charging of the cell capacitance. The tradeoff, of course, is that fast kinetic processes in the cell will

not be so accurately resolved. Another application might be to smooth a sine wave stimulus that is generated by a digital pulse generator. Lower-resolution digital devices may produce an output composed of distinct steps. By using the command filter, these steps can be effectively smoothed before the stimulus is applied to the cell.

Feedback Resistor

- The feedback resistor determines the gain of the headstage in V-Clamp mode and the amount of current that can be passed in I-Clamp mode.
- The value of this resistor is set in the Gains tab under the Options button ()
- See also External Command Inputs, Headstage, Noise, Overload.

V-Clamp Mode

In V-Clamp mode, changing the value of the feedback resistor (R_f) in the headstage provides a method of changing the gain of the headstage. Choice of the appropriate R_f involves a tradeoff between two competing factors. (See Chapter 5, **HEADSTAGE**, for a technical discussion of these factors.)

- *Larger* R_f means *smaller* current noise due to the headstage circuitry.
- *Smaller* R_f means a *larger* range of membrane currents can be measured without saturating the headstage circuitry.

Thus, larger values of R_f are more suited to patch recordings, where the noise is more critical and the currents are smaller, whereas smaller values of R_f are more suited to whole-cell recordings, with their larger currents. The following table summarizes these properties for different values of R_f .

| Feedback Resistor | Experiment Type | Range | Noise* |
|-------------------|-----------------|------------|-------------|
| 50 M Ω | Whole Cell | 1-200 nA | 3.0 pA rms |
| 500 M Ω | Whole Cell | 0.1-20 nA | 1.4 pA rms |
| 5 G Ω | Patch | 10-2000 pA | 0.9 pA rms |
| 50 G Ω | Patch | 0.2-200 pA | 0.28 pA rms |

*Bandwidth 10 kHz using an 8-pole Bessel filter. Noise is measured with the headstage open-circuit; *i.e.* it represents the best possible intrinsic noise of the headstage circuitry.

Note: V_{cmd} is limited to 10 V in the MultiClamp 700B, which in turn limits the maximum amount of current that can be injected through the headstage resistor into the electrode. For example, with $R_f = 500 \text{ M}\Omega$, the maximum current that can be injected is $10 \text{ V}/500 \text{ M}\Omega = 20 \text{ nA}$. These current limits are listed in the Options/Gains panel of the MultiClamp 700B Commander.

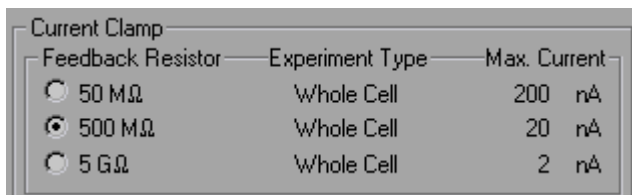

Figure 5.9

As a rule of thumb, it is best to use the largest possible value of R_f without risk of saturation. Be aware that incompletely compensated capacitance transients, which are brief and often hard to see, may saturate before ionic currents. The OVERLOAD LED on the front panel of the MultiClamp 700B will assist you in judging when saturation has occurred.



Note that R_f can be changed safely “on the fly” with a cell or patch at the end of the electrode. Under some conditions a small switching transient is generated at the input of the headstage, and the cell sees this transient. However, after extensive tests on many types of cells in all recording configurations, we have concluded that these switching transients are too small to cause any damage to the cell membrane.

I-Clamp Mode

In I-Clamp mode, R_f determines the maximum amount of current that can be injected into the cell without saturating the headstage circuitry. To enable optimal neutralization of input capacitance, R_f values should be selected to match the resistive load of the cell. If possible, the load should be in the range $R_f/10$ to $R_f \times 10$. For example, for a typical hippocampal pyramidal cell with an input resistance of $150 \text{ M}\Omega$, $R_f = 50 \text{ M}\Omega$ is suitable.

Note that changing R_f in I-Clamp mode changes the External Command Sensitivity for I-Clamp.

Filters

- Low-pass and high-pass filters can be chosen to condition the Primary Output and Scope outputs. The -3 dB frequency is selectable from a list in the Output Signals section of the main MultiClamp 700B Commander window.
- The type of low-pass filter (4-pole Bessel or Butterworth) is selected in the General tab under the Options button () .
- The command stimulus can be low-pass filtered (with a 4-pole Bessel filter) at a -3 dB frequency set in the General tab under  .
- See also External Command Inputs, Headstage, and Noise.

The theory behind the design and choice of appropriate filters is very extensive, as you will see from any book on signal processing. Here we provide just a few basic

principles that will assist you in choosing the filter type and cutoff frequency that are most suited to your experiments.

-3 dB Frequency

The -3 dB, or cutoff, frequency (f_c) of a filter is the frequency at which the output signal *voltage* (or *current*) is reduced to $1/\sqrt{2}$ (i.e. 0.7071) of the input.

Equivalently, f_c is the frequency at which the output signal *power* is reduced to half of the input. These terms arise from the definition of decibel (dB):

$$\text{Voltage: } \text{dB} = 20 \log(V_{\text{out}}/V_{\text{in}})$$

$$\text{Power: } \text{dB} = 10 \log(P_{\text{out}}/P_{\text{in}})$$

For a low-pass filter, the frequency region below f_c is called the pass band, while that above f_c is called the stop band. In the stop band, the signal attenuates (or ‘rolls off’) with a characteristic steepness. (See Figure 5.10, noting the logarithmic frequency axis.) The steepness of the roll-off at higher frequencies is determined both by the type of filter (see below) and the number of poles of the filter: the larger the number of poles, the faster the roll-off. The low-pass on the Primary Output of the MultiClamp 700B are 4-pole filters. Filters with more poles can be constructed, but they are more complex to implement and yield diminishing returns.

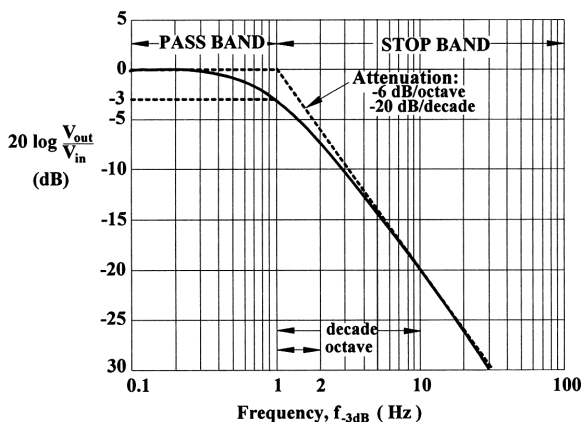

Figure 5.10. Filter characteristics, illustrated for a single-pole, low-pass filter. The spectrum has been normalized so that the signal magnitude in the pass band is 0 dB. The -3 dB frequency has been normalized to unity.

Types of Filters

There are many types of filters, distinguished by their effects on both the amplitude and phase of the signal. The two most common filters used in electrophysiology are the Bessel filter and the Butterworth filter, both of which are implemented in the MultiClamp 700B.

Bessel Filter

This is the analog filter used for most signals for which minimum distortion in the time domain is required. The Bessel filter does not provide as sharp a roll-off as the Butterworth filter, but it is well behaved at sharp transitions in the signal, such as might occur at capacitance transients or single-channel current steps.

Butterworth Filter

This is the filter of choice when analyzing signals in the frequency domain, *e.g.* when making power spectra for noise analysis. The Butterworth filter has a sharp, smooth roll-off in the frequency domain, but introduces an overshoot and “ringing” appearance to step signals in the time domain.

Choosing the Cutoff Frequency

In practice, there are two important considerations when selecting the filter cutoff frequency.

Aliasing

If the digitizing interface samples at 2 kHz, for example, any noise in the sampled signal that has a frequency greater than 1 kHz will appear in the digitized trace as extra noise in the range 0 to 1 kHz. In other words, higher-frequency noise (>1 kHz) will appear under the *alias* of lower-frequency noise (<1 kHz). This error is called aliasing. A fundamental principle of signal analysis, called the Nyquist Principle, therefore states that, in order to avoid

aliasing, the digitizing frequency (f_d) should be at least twice the filter cutoff frequency (f_c):

$$f_d \geq 2f_c$$

The minimum permissible digitizing frequency (exactly twice f_c) is called the *Nyquist frequency*. In practice, it is better to sample at two or more times the Nyquist frequency. Thus, $f_d = 5f_c$ is commonly used. This means that, if the MultiClamp 700B filter is set at 5 kHz, your interface should be capable of digitizing at 25 kHz.

Risetime

The risetime is typically given as the time taken for a signal to increase from 10% to 90% of its peak value. The more heavily a step response is filtered, the greater the 10-90% risetime. For the 4-pole Bessel filter in the MultiClamp 700B, the filtered 10-90% risetime (T_r , in ms) of a step input depends on f_c (in kHz) approximately as:

$$T_r \approx 0.35/f_c$$

(This can be measured by applying Seal Test to the model BATH in V-Clamp mode and looking at “Primary Output: Membrane Current” while changing the filter setting.) Suppose you are interested in measuring action potentials, for which you expect the 10-90% risetime to be about 0.4 ms. You would then choose the filter cutoff frequency to be high enough that the filter risetime is about ten times faster than 0.4 ms so the action potentials are minimally distorted by the filter. According to the above equation, then, the appropriate filter setting would be 10 kHz. In practice, you may need to make other compromises. For example, if the signal is very noisy you may wish to filter more heavily and accept that the action potential risetime is artifactually slowed.

High-pass Filter

The Primary Output and Scope signals can be high-pass filtered by setting the AC value in the Output Gains and Filters section of the main MultiClamp 700B Commander panel. This is typically done in order to remove a DC component of the signal. When the filter cutoff is set to DC this high-pass filter is bypassed.

Command Filter Frequency

Command stimuli applied in V-Clamp or I-Clamp can be filtered at different cutoff frequencies, selectable in the General tab under the Options button. You might wish to do this in order to smooth out sharp transitions in the command signal that, if unfiltered, might produce very large capacitance transients that saturate the headstage circuitry, even after capacitance compensation. (See Chapter 5, **EXTERNAL COMMAND INPUTS**.)

Grounding and Hum

- Methods for minimizing line-frequency noise.
- See also Noise, Power Supply.

A perennial bane of electrophysiology is line-frequency pickup, often referred to as hum. Hum can occur not only at the mains frequency but also at multiples of it.

In a well-shielded enclosure the MultiClamp 700B has insignificant hum levels (less than 0.01 pA_{p-p}). To take advantage of these low levels great care must be taken when incorporating the MultiClamp 700B into a complete recording system. The following precautions should be taken.

- **Ground the preparation bath only by directly connecting it to the gold ground connector on the back of the headstage.**
- Place the MultiClamp 700B in the rack in a position where it will not absorb radiation from adjacent equipment. A grounded, thick sheet of steel placed between the MultiClamp 700B and the radiating equipment can effectively reduce induced hum.

- Initially make only one connection to the MultiClamp 700B, from the PRIMARY OUTPUT BNC to the oscilloscope. After verifying that the hum levels are low, start increasing the complexity of the connections one lead at a time. Leads should not be draped near transformers located inside other equipment. In desperate circumstances, the continuity of the shield on an offending coaxial cable can be broken.
- Try grounding auxiliary equipment from a ground distribution bus. This bus should be connected to the MultiClamp 700B via the SIGNAL GROUND (4 mm) socket on the rear panel. The Signal Ground in the MultiClamp 700B is isolated from the chassis and power ground.
- Experiment. While hum can be explained in theory (*e.g.* direct pickup, earth loops), in practice empiricism prevails. Following the rules above is the best start. The final hum level can often be kept to less than 0.1 pA_{p-p}. One technique that should **not** be used to reduce hum is the delicate placement of cables so that a number of competing hum sources cancel out. Such a procedure is too prone to accidental alteration.

Headstage

- Principles and properties of the V-Clamp and I-Clamp circuits in the CV-7 headstage.
- See also Feedback Resistor, Mode, Noise, Series Resistance Compensation.

The CV-7 headstage contains two distinct circuits, a current-to-voltage (I-V) converter used in V-Clamp mode, and a voltage follower used in I-Clamp mode. The I-V converter is similar to that found in an Axopatch-1D headstage, whereas the voltage follower is like that in an Axoclamp 2B headstage.

Voltage Clamp Circuit

In V-Clamp mode, the goal is to hold the interior of an electrode at a command potential while measuring the currents that flow down the electrode. An I-V converter achieves this by producing a voltage output that is proportional to the current input. There are two types of I-V converters used in patch clamp headstages: capacitive feedback (used in the Axopatch 200B), and resistive feedback (used in the Axopatch-1D and in the MultiClamp 700B). The essential parts of a resistive-feedback headstage are shown in Figure 5.11.

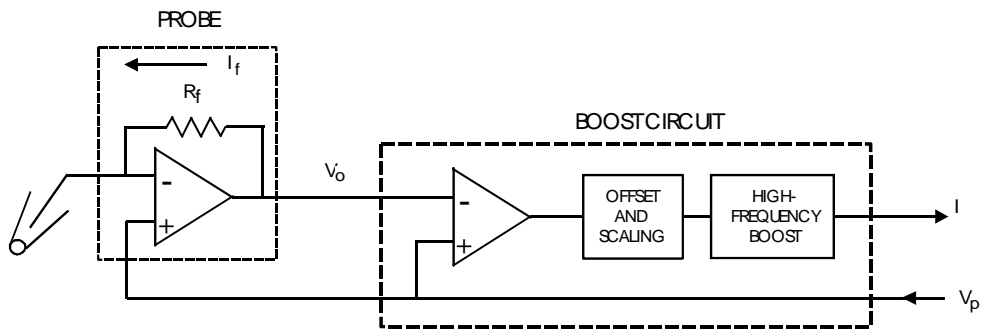

Figure 5.11. Resistive-feedback headstage.

The heart of the circuit is an operational amplifier (op amp) in the PROBE. The behavior of this circuit depends upon two characteristics of an ideal op amp.

- An op amp has infinite input resistance. Therefore, the current flowing out of the electrode (I_e) must equal the current (I_f) flowing through the feedback resistor (R_f) because no current is allowed to flow into the ‘-’ input of the op amp.
- An op amp does all it can to keep the voltage at its two inputs equal. Thus, because the voltage at the ‘+’ input is V_p (= the command voltage), the voltage at its ‘-’ input is also V_p . The voltage across R_f must therefore be $V_p - V_o = I_f \cdot R_f$ by Ohm’s Law.

Combining both of these pieces of information, the electrode current (which is what we want) is given by $I_e = I_f = (V_p - V_o)/R_f$. In practice R_f is a very large resistor

(G Ω) so this circuit can measure very small currents (pA). The differential amplifier in the BOOST CIRCUIT does this calculation of I_e . Subsequent amplifiers are used to scale the gain and remove voltage offsets.

High Frequency Boost

A fundamental problem of this circuit when used for patch clamping is that the output bandwidth of the probe is inherently low. To a first approximation, the product of R_f and the stray capacitance sets the bandwidth across it. For example, if R_f is 500 M Ω and the stray capacitance is 0.5 pF, the bandwidth is about 600 Hz. To overcome this limitation, the probe output is passed through a high-frequency boost circuit. The gain of this circuit is proportional to the frequency.

The high-frequency boost is applied to the output of the I-V converter and cannot influence the events at the electrode. Thus, one might conclude that the voltage clamp of the electrode must also be slow. This is not the case, for the following reason. The PROBE op amp does everything it can to keep the voltage at its ‘-’ input equal to the command voltage at its ‘+’ input. If the command is a rapid step, then the voltage at the ‘-’ input (*i.e.* at the back of the electrode) is also a rapid step. This means the voltage clamp of the electrode is fast. The RC filtering effect mentioned above applies only to the *output* of the I-V converter, which can therefore be subjected to *post hoc* boosting.

What is Clamped During Voltage Clamping?

We were careful to state in the above discussion that it is only the back of the electrode that is voltage clamped, not the cell membrane. The voltage at the cell membrane may differ from that at the back of the electrode because of bandwidth and voltage errors due to uncompensated series resistance (R_s). For this reason, it is always important to consider using R_s compensation. (See Chapter 5, **SERIES RESISTANCE COMPENSATION**.)

Intrinsic Headstage Noise

The intrinsic noise of a resistive-feedback I-V converter (*i.e.* with an open-circuit input) is determined, in theory, by the resistance of the feedback resistor. The rms current noise is given approximately by

$$I_{rms} \approx \sqrt{(4kTf_c/R_f)}$$

where f_c is the filter cutoff frequency and k and T are constants. Thus, for low noise, a high value of R_f is desirable. This was pointed out in Chapter 5, **FEEDBACK RESISTOR**.

Current Clamp Circuit

In I-Clamp mode a separate headstage circuit is used, called a voltage follower. The essential features of a voltage follower are shown in Figure 5.12. A1 is an (effectively) infinite input resistance, unity-gain op amp, the output of which is the pipette voltage, V_p . A2 is a summing amplifier used for injecting current into the cell. The voltage across the headstage resistor R_f is equal to V_{cmd} regardless of V_p . Thus the current through R_f is given exactly by $I = V_{cmd}/R_f$. If stray capacitances are ignored, all of this current is injected into the cell.

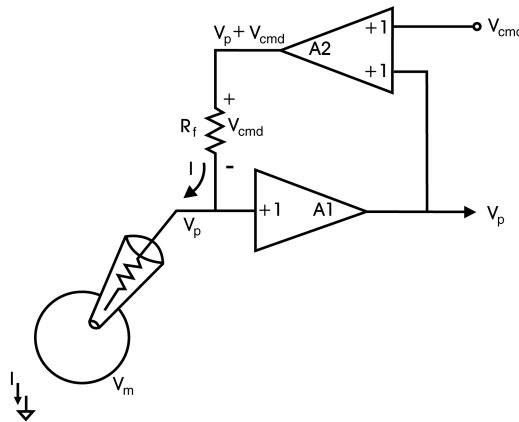

Figure 5.12. Voltage follower headstage.

Note that V_{cmd} is limited to 10 V in the MultiClamp 700B, which in turn limits the maximum amount of current that can be injected through the headstage resistor into the electrode. For example, with $R_f = 500 \text{ M}\Omega$, the maximum current that can be injected is $10 \text{ V}/500 \text{ M}\Omega = 20 \text{ nA}$. These current limits are listed in the Options/Gains panel of the MultiClamp 700B Commander.

Mounting the Headstage

For maximum mechanical rigidity, the CV-7 headstage should be mounted directly to the head of the micromanipulator using the dovetailed mounting plate.

Bath Connection

The bath (or ground) electrode should be connected to the gold-plated 1 mm plug on the rear of the headstage. The bath should not contact any other ground (*e.g.* Signal Ground).

Cleaning

Wipe the headstage connector with a damp cloth to clean salt spills. Avoid spilling liquids on the headstage. The Teflon input connector should be kept very clean. Effective cleaning can be done by spraying with alcohol or swabbing carefully with deionized water.

Static Precautions

The headstage can normally be safely handled. However, if you are in a laboratory where static is high (*i.e.* you hear and feel crackles when you touch things) you should touch a grounded metal object immediately before touching the headstage.

Acoustic Pick-up

Rare cases have been reported in which the headstage was susceptible to low amplitude acoustic pick-up. For example, the audible hum of a nearby isolation

transformer can acoustically couple to the input of the headstage. This was traced to the silver wire of the electrode and was solved by trimming off a fraction of the wire, thus changing its resonant frequency.

Help

- On-line Help facility used to provide brief descriptions of the features of the MultiClamp 700B Commander.
- Help is accessed via the  button at the top of the main MultiClamp 700B Commander window.

In order for the On-line Help to work properly, the computer running the MultiClamp 700B Commander must have a web browser (Internet Explorer v. 4 or later, or equivalent). JavaScript is required. When the user clicks on the Help button, the browser will open automatically (if it is not already running) and the relevant page will appear.

Holders

- Design, use and maintenance of the HL-U electrode holders supplied with the MultiClamp 700B.

The HL-U series holder provides a universal fit for a very wide range of electrode diameters and will fit any of the U-type headstages of Axon amplifiers.

Holder Design

The barrel of the holder is made of polycarbonate for lowest noise. There are two different barrel lengths (16 mm and 28 mm). The shorter length contributes less to instrument noise and is therefore suited to single-channel patch clamp recordings. Although the longer barrel will contribute more to the noise, the greater length may provide the needed clearance between the headstage case and other components in the experimental setup. To further minimize the noise contributed by the holder in

single-channel recording, the holder uses a small (1 mm) pin for the electrical connection and a large amount of insulating Teflon.

Mechanical stability of the electrode is assured in several ways. (See Figure 5.13.) As the pipette cap is closed, the cone washer is compressed on the electrode from the force applied to the front and back of the cone washer. The cap also forces the blunt end of the electrode against the rear wall of the holder bore. (The electrode should always be inserted as far as it will go in the holder.) The holder mates with the threaded Teflon connector on U-type Axon headstages and is secured in place with a threaded collar.

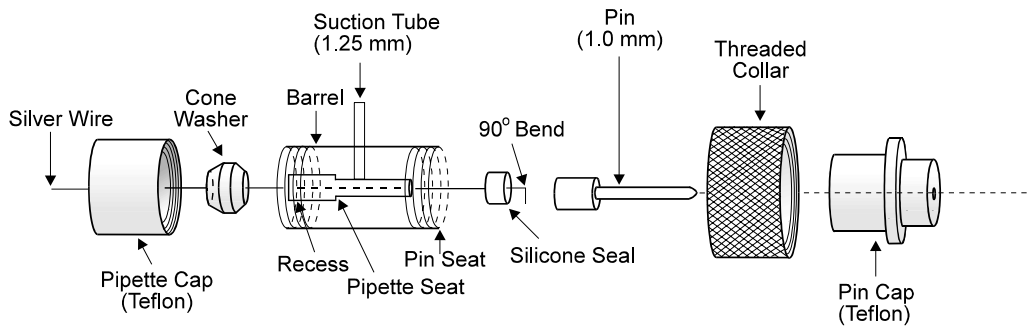

Figure 5.13. Exploded view of the HL-U holder.

The bore size of the HL-U accepts pipettes with an outer diameter (OD) of 1.0-1.7 mm. Pipettes are secured by a cone washer with an inner diameter (ID) that accommodates the pipette OD. Color-coding aids identification of the four sizes of cone washers:

1.0 mm (orange), 1.3 mm (clear), 1.5 mm (orange) and 1.7 mm (clear). When the pipette OD falls between two sizes of cone washers, the larger size cone washer should be used. For instance, if the pipette OD is 1.6 mm, then use a cone washer with an ID of 1.7 mm.

An Ag/AgCl pellet offers no greater stability than properly chlorided silver wire. Moreover, the diameter of the pellet (1 mm) restricts its use to pipettes with a large

ID (> 1.1 mm). Therefore, the HL-U is supplied with 0.25 mm silver wire, which must be chlorided before use. (See below.)

Spare components included with each holder are: one 50 mm length of silver wire, 40 cone washers (10 of each size), and one 70 mm length of silicone tubing. Cut into 2 mm lengths, the silicone tubing will yield approximately 30 replacement silicone seals. Additional cone washers, silicone tubing, pins and silver wire can be purchased from Axon Instruments, as well as optional Ag/AgCl pellet assemblies.

Optional Ag/AgCl Pellets

The HL-U holder will accommodate a 1 mm diameter Ag/AgCl pellet that should provide many months of DC-stable recordings. The inner diameter (ID) of the pipette must be > 1 mm. A wax-sealed Teflon tube surrounds the silver wire. This ensures that the electrode solution only contacts the Ag/AgCl pellet. Three pellet assemblies are sold as HLA-003.

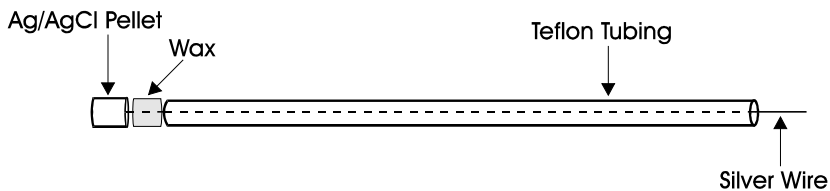

Figure 5.14. Ag/AgCl pellet assembly.

Holder Use

Insertion of Electrode

Make sure the electrode cap is loosened so that pressure on the cone washer is relieved, but do not remove the cap. Push the back end of the electrode through the cap and cone washer until it presses against the end of the bore. Gently tighten the cap so that the electrode is gripped firmly.

To minimize cutting of the cone washer by the sharp back end of the electrode, you can slightly smooth the edges by rotating the ends of the electrode glass in a Bunsen burner flame prior to pulling.

Filling Electrodes

Only the taper and a few millimeters of the shaft of the pipette should be filled with solution. The chlorided tip of the wire should be inserted into this solution. Avoid wetting the holder since this will increase the noise.

Silver Chloriding

It is up to you to chloride the end of this wire as required. Chloriding procedures are contained in many electrophysiology texts¹. Typically the chlorided wire will need to be replaced or rechlorided every few weeks. A simple yet effective chloriding procedure is to clean the silver wire down to the bare metal using fine sand paper and immerse the cleaned wire in bleach for about 20 minutes, until the wire is uniformly blackened. This provides a sufficient coat of AgCl to work reliably for several weeks. Drifting or otherwise unstable offsets during experiments is suggestive of the need for rechloriding. The chlorided region should be long enough so that the electrode solution does not come in contact with the bare silver wire.

Heat smoothing the back end of the electrode extends the life of the chloride coating by minimizing the amount of scratch damage. Another way to protect the AgCl coating is to slip a perforated Teflon tube over the chlorided region.

¹For easy-to-use recipes see *Microelectrode Methods for Intracellular Recording and Ionophoresis*, by R.D. Purves, London: Academic Press, 1981, p. 51 or *The Axon Guide*. Foster City, CA: Axon Instruments, Inc., 1993, p. 83.

Holder Maintenance

Cleaning

For lowest noise, keep the holder clean. Frequently rinse the holder with distilled water. If more thorough cleaning is required, briefly wash in ethanol or mild soapy water. Never use methanol or strong solvents.

Replacing the Silver Wire

To replace the silver wire, insert the nonchlorided end through the hole of the silicone seal and bend the last 1 mm of wire over to an angle of 90°. Press the wire into the back of the barrel making sure that the silicone seal is flush with the back of the barrel. Slip the threaded collar over the back of the barrel.

Adapters

HLR-U right-angle adapters allow the HL-U series holder to emerge at 90° from the headstage. Use the HLR-U with the HL-U holder.

HLB-U BNC-to-Axon adapter allows conventional BNC-type holders to be used with Axon U-type headstages. Use the HLB-U with all U-type CV and HS headstages. These headstages have a threaded white Teflon collet.

Input/Output Connections

- Description of the different connectors on the front and rear panels of the MultiClamp 700B main unit.
- See also External Command Inputs, Oscilloscope Triggering, Mode.

Front Panel

Inputs

COMMAND: Voltage or current commands to the MultiClamp 700B are accepted at this input. The External Command Sensitivity is set in the Gains panel under the Options toolbar button.

MODE: This is enabled when the user has checked the Ext checkbox under Channel 1 or 2 Mode in the MultiClamp 700B Commander. A TTL Low input at MODE will select I-Clamp; a TTL High (3.5-5 V) input will select V-Clamp. For example, these inputs can be a TTL Digital Signal controlled by pCLAMP.

Scaled Outputs

PRIMARY: The output signal at this BNC is selected from the list in the Primary Output section of the main window of the MultiClamp 700B Commander. The choices include:

- Membrane Current
- Membrane Potential
- Pipette Potential (VC) or Command Current (IC)
- 100 x AC Membrane Potential (High-passed filtered at 1 Hz, this special high-gain output is useful for viewing very small extracellular signals.)
- External Command Potential (VC) or Current (IC)
- Auxiliary Potential (if HS-2 headstage attached) or Current (if VG-2 headstage attached).

SCOPE: The signal available here is the same as that at PRIMARY OUTPUT, except that it can be independently low-pass filtered using the Scope control in the Primary Output section of the main window of the MultiClamp 700B Commander.

SECONDARY: The output signal at this BNC is selected from the list in the Secondary Output section of the main window of the MultiClamp 700B Commander. All signals are identical to the Primary outputs, except that Membrane Potential also includes the commands applied by the Rs Compensation circuitry.

Headphone Jack: This will drive headphones or a remote powered speaker if it is desired to monitor the audio output of the MultiClamp 700B. The output is the same as that available at the rear panel AUDIO OUTPUT jack.

Rear Panel

HEADSTAGE #1 / #2: The CV-7 headstages are plugged into the corresponding 25-pin DB connectors. Note that Headstage #1 refers to Channel 1 inputs/outputs on the front panel, and Headstage #2 for Channel 2 inputs/outputs.

AUXILIARY HEADSTAGE #1 / #2: The optional voltage-following (HS-2) or Bath (VG-2) is plugged into this 15-pin DB connector.

10 AUX1/ 10 AUX2: These BNC outputs provide x10 output signal for the respective AUXILIARY HEADSTAGE channels.

USB: The USB port of the host computer is connected via of a USB cable.

AUDIO INPUT: This connector is used if you wish to mix the audio output of the MultiClamp 700B with the audio output of your PC. Connect the audio output of your PC's sound card to the AUDIO INPUT socket and the MultiClamp AUDIO OUTPUT socket to the PC-powered speakers.

AUDIO OUTPUT: This output can be used in conjunction with AUDIO INPUT, as described above. It can also drive headphones or a remote powered speaker, like the front panel Headphones Socket.

SYNC OUTPUT: The signal available at this BNC connector is intended to be used as an external trigger for an oscilloscope when internal commands (Seal Test), Tuning) or Pulse are activated, or to indicate the Mode state of the amplifier (commanded either externally by the Mode BNC or internally by the Auto Mode switch feature). The Sync Output is a 0 to (approximately) 5 V step aligned with the onset of the Seal Test, Tuning or Pulse step. Or, when following Mode, 5 V corresponds to VC, while 0 V corresponds to IC. See the Options / General tab to select the function of the SYNC output.

SIGNAL GROUND: This 4 mm socket is an alternative signal grounding point for the MultiClamp 700B, and is isopotential with the CV-7 input signal. It can be connected to a central grounding bus in order to combine other sources of noise in your setup, such as the Faraday cage, perfusion system, etc.

Screw connector with nut (labeled with standard ground symbol): This provides an alternative chassis or power supply ground.

Leak Subtraction

- Leak Subtraction provides a quick method of subtracting linear leak currents from the Membrane Current in V-Clamp mode.
- Leak Subtraction is activated by checking the Checkbox and pressing the  button in the Leak Subtraction box in the V-Clamp pane.
- See also Capacitance Compensation.

Leak Subtraction is typically used when you are trying to measure single-channel currents that are sitting on top of a relatively large leak current. Imagine, for example, a channel that opens during a 100 mV voltage step that is applied to a patch with a 1 G Ω seal resistance. The seal (leak) current during the step will be 100 pA. Because of this relatively large leak current, the gain of the MultiClamp 700B cannot be turned up very far without saturating the amplifier, but at a low gain setting the single-channel openings may not be resolved very well.

Leak Subtraction solves this problem by subtracting from the membrane current, in this case, a 100 pA step of current before the Output Gain is applied. The Primary Output signal will now be a flat line on which the single-channel activity is superimposed. (This assumes that the capacitance transients at the start and end of the step have already been canceled using Capacitance Compensation. Indeed, Leak Subtraction can be thought of as a kind of capacitance compensation that applies to leak currents.)

Leak Subtraction works by scaling the command potential waveform ($V_c(t)$) by the seal resistance (R_{seal}) to obtain a time-varying estimate of the leak current ($I_{leak}(t)$), which is then subtracted from the membrane current. It differs from Output Zero, which simply subtracts a constant offset without regard to changes in the command potential with time. In order to perform its correction, Leak Subtraction must be provided with an estimate of R_{seal} . This is done by pressing the Auto Leak Subtraction button, or by manually entering an estimate of R_{seal} to the right of the button. When it is correctly adjusted, voltage steps that are known to elicit no active currents (*e.g.* small hyperpolarizing steps) will produce a flat line in the Membrane Current signal (ignoring the brief capacitance transients, if these are still uncompensated).

We recommend that Leak Subtraction be used with caution, because it assumes that R_{seal} is constant for all voltage steps. This may not be true if, for instance, the patch contains small channels or electrogenic transporters that do not produce discernible single-channel events. These will appear to be part of the seal current and may impart apparent non-linear behavior to the seal.

For subtracting leak currents in whole-cell recordings, it is safer to use a computer program like pCLAMP, which allows off-line leak correction.

Mode

- Recording mode is switchable between voltage clamp (VC), normal current clamp (IC) and current clamp in which all external inputs are disconnected ($I=0$).
- Mode is selected using the VC I=0 IC buttons, or remotely by checking the Ext check box and applying a voltage to the MODE input on the front panel of the MultiClamp 700B (0 V for IC, 3.5-5 V for VC).
- See also Headstage, Input/Output Connections.

Switching between V-Clamp and I-Clamp modes in the MultiClamp 700B activates a switch between two distinct circuits in the CV-7 headstage. Voltage clamp is achieved with a current-voltage converter, whereas current clamp is achieved with a

voltage follower. This contrasts with the design of other patch clamp amplifiers, in which the same basic circuit is used for voltage clamp and current clamp, producing a compromised performance.

The $I=0$ mode is a special case of I-Clamp in which all external inputs are disconnected. This is convenient if you wish to quickly return to the resting potential of the cell, or if you want to check the electrode offset at the end of the experiment. (See Chapter 4, **GENERAL ADVICE**.)

Mode switching in the MultiClamp 700B can, under some circumstances, produce a small transient at the input of the headstage, a transient that is seen by the cell. We have extensively tested the headstage with many cell types and all recording configurations, and have not encountered any problems with the transients causing damage of the cell membrane.

Model Cell

- PATCH-1U model cell is a standard accessory provided with the MultiClamp 700B. It is useful for setting up, testing and doing the tutorials described in Chapter 3.

The model cell is a small metal box with three connectors labeled BATH, CELL and PATCH, and an unlabeled 2 mm gold plug which connects to the 1 mm grounding plug on the rear of the CV-7 headstage. The circuit is shown in Figure 5.15 (right). A 10 M Ω resistor models the electrode, the cell is modeled by 500 M Ω in parallel with 33 pF (the membrane time constant is 16.5 ms), and a 10 G Ω resistor models the patch. The pipette capacitance is about 4-6 pF. The charging time constant is approximately 330 μ s (10 M Ω x 33 pF).

The PATCH-1U model cell has been made without a switch to change the model between the BATH, PATCH and CELL positions. This is because even the best switches have an enormous amount of leakage resistance and capacitance that increases the noise three to five times beyond what can be achieved with a good seal. Instead of switches, three separate plug positions have been provided and you can rotate the model cell into the position required. With this technique the noise contribution of the model cell is still somewhat more than can be achieved with a good seal, but the increase is less than 50%.

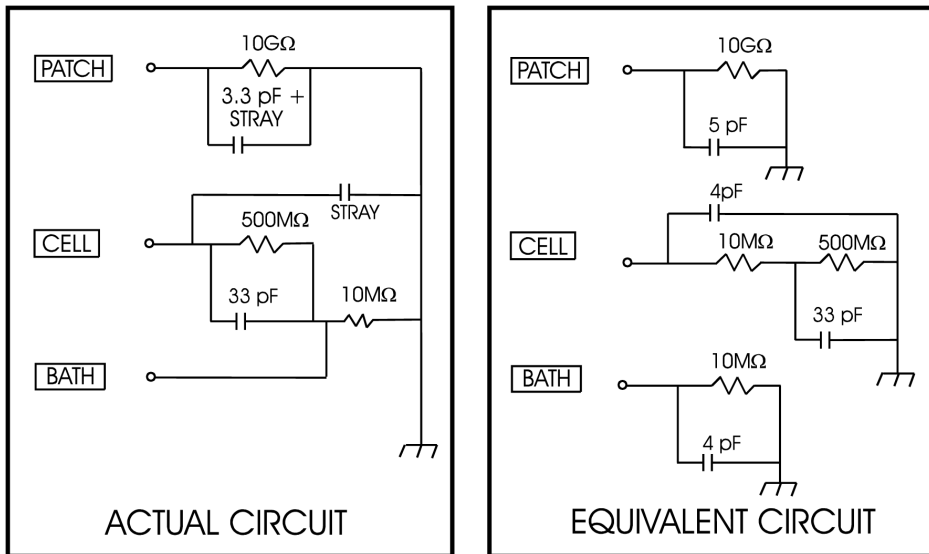

Figure 5.15. PATCH-1U model cell.

Noise

- Sources of instrument noise in the MultiClamp 700B.
- See also Feedback Resistor, Filters, Grounding and Hum, Headstage, Power Supply, Series Resistance Compensation.

Measurement of Noise

Noise is reported in two different ways in this manual.

- Peak-to-peak (*p-p*) noise. This measure finds favor because it is easily estimated from an oscilloscope and its meaning is intuitively obvious. A disadvantage is that it is very insensitive to structure in the noise (*e.g.* different frequency components). For this reason, it is most commonly used for quantifying “white” noise. (See Chapter 5, **FILTERS**.)
- Root-mean-square (*rms*) noise. This is essentially the “standard deviation” of the noise and can be calculated using a computer or an electronic circuit designed for this purpose. For white noise, the rms noise is approximately one-sixth the peak-to-peak noise. The MultiClamp 700B Commander displays the rms noise on the Membrane Current signal in V-Clamp mode after checking the Irms checkbox below the meters. The measurement is made with a bandwidth of 30 Hz to 5 kHz (4-pole Butterworth filter). See the table on page 92 in the Feedback Resistor section for noise measurements using the CV-7 headstage.

When reporting measured noise, the bandwidth (*i.e.* filter cutoff frequency) must always be stated.

Sources of Noise

Cell and Seal

V-Clamp: The higher the resistance (*R*) and the smaller the capacitance (*C*) between the interior of the electrode and ground, the smaller the current noise. Thus, minimum noise is achieved for an isolated patch (large *R*, small *C*) with a high seal resistance (large *R*). In whole-cell recordings

from larger cells (smaller R , larger C) the noise of the cell usually dominates, meaning that subsequent noise sources (listed below) become less important. (See Chapter 4, **PATCH CLAMPING**.)

I-Clamp: The voltage noise is dominated by the load resistance but is also affected by the stray capacitance. For a purely resistive load the noise is given approximately by $12\sqrt{R}$ μV_{rms} (10 kHz bandwidth), where R is the parallel combination of the feedback resistor (R_f) and the load resistance (*i.e.* the electrode resistance plus input resistance of the cell). Thus, a low resistance electrode/cell combination is preferred. A large stray capacitance will reduce the noise by acting like an RC filter, but this will also reduce the measurement bandwidth. Increasing the Capacitance Neutralization setting will improve the bandwidth but increase the noise.

Electrode and Holder

V-Clamp: Current noise increases markedly with electrode capacitance. This can be minimized by coating the electrode and other strategies. (See Chapter 4, **PATCH CLAMPING**.) Increasing electrode resistance apparently decreases the current noise, but this is due to the RC filtering effect of the electrode resistance in parallel with the electrode capacitance. In fact, it is desirable to *decrease* the electrode resistance in order to maximize the bandwidth of the clamp, even if this apparently increases the noise of the recording.

I-Clamp: Voltage noise increases markedly with electrode capacitance and resistance. Thus, both should be minimized as much as possible. (See Chapter 4, **SHARP MICROELECTRODE RECORDING**.)

Headstage Circuit

V-Clamp: Current noise decreases as the value of the feedback resistor (R_f) is increased. Thus, for minimum noise the largest R_f should be chosen, subject of course to range limitations. (See Chapter 5, **FEEDBACK RESISTOR**.)

I-Clamp: Voltage noise decreases as the value of R_f is decreased, but R_f should be chosen so that it matches the load resistance (*i.e.* sum of electrode and cell resistance) within a 1:10 ratio (a 1:5 ratio is optimal). Thus, $R_f = 50 \text{ M}\Omega$ will work optimally for loads between $10 \text{ M}\Omega$ and $250 \text{ M}\Omega$. This range limitation is determined by the effectiveness of the Capacitance Neutralization circuit.

Compensation Circuits

V-Clamp: Adjusting R_s Compensation increases the current noise, because the compensation circuit employs positive feedback that injects noise back into the headstage. Further, the effect of R_s compensation is to reduce the electrode series resistance, which reduces the effect of the RC filter mentioned above (“Electrode and Holder”).

I-Clamp: Increasing Pipette Capacitance Neutralization increases the voltage noise, for reasons similar to those just mentioned for R_s Compensation.

Although both of these compensation circuits increase the noise in the signal of interest, they are most likely to be required in whole-cell recordings where the dominant noise source is the cell. In any case, correction of Series Resistance and Pipette Capacitance errors must normally take precedence over noise concerns in whole-cell experiments.

Power Supply

Noise can arise from earth loops, power supply glitches and radiation from nearby instruments. (See Chapter 5, **GROUNDING AND HUM**, and **POWER SUPPLY**.)

Oscilloscope Triggering

- SYNC output on the rear panel of the MultiClamp 700B provides a signal for triggering an oscilloscope (or for triggering in Clampex).

- See also Input/Output Connections.

The signal available at this BNC connector is intended to be used as an external trigger for an oscilloscope when internal commands (Seal Test), Tuning) or Pulse are activated, or to indicate the Mode state of the amplifier (commanded either externally by the Mode BNC or internally by the Auto Mode switch feature). The Sync Output is a 0 to (approximately) 5 V step aligned with the onset of the Seal Test, Tuning or Pulse step. Or, when following Mode, 5 V corresponds to VC, while 0 V corresponds to IC. See the Options / General tab to select the function of the SYNC output.

Output Zero

- Subtracts the steady-state current offset (in VC mode) or voltage offset (in IC mode).
- Activated by pressing the button in the Output Zero box, or by checking the checkbox and manually adjusting the value to the left of the button.
- See also Leak Subtraction, Bridge Balance.

The purpose of this control is to zero the output, that is, to remove the DC voltage. Output Zero works by sampling the current or voltage over a ~70 ms time window immediately after pressing the button, and then subtracting this value from all subsequent Primary Output signals. Unlike Leak Subtraction or Bridge Balance, it does not account for currents or voltages that change as a result of time-varying command pulses; it simply provides a constant offset adjustment.

The Auto Output Zero only affects the signal on the Primary Output. In other words, the cell is not affected by the Output Zero command. No other input or outputs are affected.

Output Zero is useful for recording small signals that are riding on a large, constant offset current or voltage. However, in general we recommend that it not be used, since potentially useful information about the biological signal is lost.

Overload

- OVERLOAD light on the front panel of the MultiClamp 700B warns when the signal presented at PRIMARY OUTPUT or SCOPE saturates (*i.e.* exceeds ± 10.5 V longer than 10 μ s) at any point in the internal circuitry of the amplifier.
- See also Capacitance Compensation, Feedback Resistor.

Inadvertent overloading of the internal circuitry of the MultiClamp 700B is a problem because it may cause distortion of the signal of interest. The OVERLOAD light helps to avoid this problem in two ways.

- By reporting saturation in internal circuits. The PRIMARY OUTPUT might not appear to be saturated because it may be heavily filtered, reducing the size of any saturating transients at the output. OVERLOAD reports any saturation that occurs before the signal is conditioned.
- By expanding transients. Very fast saturating spikes (*e.g.* uncompensated capacitance transients) may be missed under visual inspection on an oscilloscope, because they are too fast to be seen clearly. The overload sensing circuitry in the MultiClamp 700B catches any signals that exceed saturation for longer than 10 μ s and illuminates the OVERLOAD light for at least 500 ms.

If saturation occurs, first try reducing the Output Gain. If the problem persists, indicating that saturation occurs in the headstage, reduce the Feedback Resistor.

Polarity Conventions

- Current and voltage sign conventions used in the MultiClamp 700B system.

Biological Polarity Conventions

Inward Current

Current (carried by positive ions) that flows across the cell membrane, from the outside surface to the inside surface.

Outward Current

Current that flows from the inside to the outside surface of the cell.

Membrane Potential

The potential inside the cell minus the potential outside the cell:

$$V_m = V_{in} - V_{out}.$$

Depolarization

A positive shift in V_m (e.g. from -60 mV to $+80$ mV) caused by a flow of inward current.

Hyperpolarization

A negative shift in V_m .

MultiClamp Polarity Conventions

The conventions described here apply to all amplifiers manufactured by Axon Instruments.

To prevent confusion, Axon always uses current and voltage conventions based on the instrument's perspective. That is, the current is defined with respect to the direction of flow into or out of the headstage. Axon amplifiers do not have switches that reverse the current or the voltage command polarities. This prevents forgetting to move the switch to the correct position. The data are recorded unambiguously and the correct polarity can be determined during subsequent data analysis.

Positive Current

Current that flows *out* of the headstage into the electrode and out of the electrode tip into the cell.

Positive/Negative Potential

A positive/negative voltage at the headstage input with respect to the bath ground.

With these definitions it is easy to work out the correct polarity for every recording configuration. For example, in the whole-cell or outside-out patch configuration the electrode tip is on the intracellular face of the cell. Thus, a *negative* potential, V_p , at the headstage input (=electrode interior) is a *negative* potential inside the cell. The cell's membrane potential under voltage clamp is therefore $V_m = V_{in} - V_{out} = V_p - 0 = V_{cmd}$. *Positive* current flowing out of the electrode must then flow from the inside to the outside surface of the cell, which means that it is *outward* current.

Polarity Summary for Different Recording Configurations

Whole Cell/Outside-out Patch

Positive current = outward membrane current

Membrane potential = V_p

Inside-out Patch

Positive current = inward membrane current

Membrane potential = $-V_p$

Cell-attached Patch

Positive current = inward membrane current

Membrane potential = $V_{rest} - V_p$

Power Supply

- Behavior and maintenance of the power supply used in the MultiClamp 700B.
- See also Grounding and Hum.

Supply Voltage Selection

The MultiClamp 700B can be directly connected to all international supply voltages. The input range is from 85 to 260 V_{AC}. No range switching is required. Alternatively, a DC voltage of 110 – 340 V_{DC} can power the instrument.

Changing the Fuse

The MultiClamp 700B uses a 0.5 A, 250 V slow acting 5 x 20 mm fuse. Before changing the fuse investigate the reason for its failure. To change the fuse:

1. **Disconnect the power cord.**
2. Use a screwdriver or a similar device to rotate the fuse holder counterclockwise.
3. Replace the fuse with another fuse of the same rating.
4. Reconnect the power cord.

Glitches

The MultiClamp 700B has been designed to minimize the effects of power-supply transients (glitches). Although normally inconsequential, glitches could cause transients to appear on the voltage and current outputs that may corrupt high-sensitivity recordings.

The most effective way to gain immunity from mains glitches is to eliminate them at the source. Most glitches are due to the on/off switching of other equipment and lights on the same power-supply circuit. Precautions to be taken include:

1. Avoid switching equipment and lights on or off while recordings are being made.
2. Water baths, heaters, coolers, etc. should operate from zero-crossing relays.
3. Radio Frequency Interference filters should be installed in glitch-producing equipment.

Select Device

- Selection of Demo or Hardware modes and the Serial number.
- Selection is made using the Select Device () button in the toolbar.

When the MultiClamp 700B Commander is run for the first time, the Select Device window is displayed. (See Chapter 2, **INSTALLATION AND BASIC OPERATION**.) When the MultiClamp 700B Commander is run subsequently, this window is bypassed. The window can be accessed again by pressing the Select Device toolbar button.

Select Device offers the following options.

- **Demo Mode.** This allows the MultiClamp 700B Commander to be run without a MultiClamp 700B amplifier being connected or switched on. Demo Mode is useful for exploring the features of the MultiClamp 700B Commander. Note that telegraphs are active during Demo mode, since they are communicated through software messaging.
- **MultiClamp Hardware.** This option only works when a functioning MultiClamp 700B is connected to a USB port on the computer that is running the MultiClamp 700B Commander. The unique hardware Serial Number is identified by this operation.

Series Resistance Compensation

- Theory and practice of compensating the series resistance in V-Clamp mode.
- Adjusted using the **R_s Compensation** controls in the V-Clamp pane.
- See also Capacitance Compensation, Headstage.

Introduction to R_s Compensation

Series resistance (R_s) is defined as the total resistance that is interposed between the circuitry of the headstage and the membrane of the cell. Contributors to R_s include:

- The resistance of the solution inside the electrode, dominated by that at the narrow tip.
- The resistance caused by intracellular organelles that partially clog the electrode tip.
- The resistance due to glial cells or connective tissue that cover the cell membrane.
- The resistance of the bath solution and the bath electrode (usually minor).

Series resistance causes three major problems in voltage clamp recordings.

1. **Steady-state voltage errors.** Suppose you are measuring a 1 nA membrane current under V-Clamp. If $R_s = 10 \text{ M}\Omega$, there will be a voltage drop of $IR_s = 1 \text{ nA} \times 10 \text{ M}\Omega = 10 \text{ mV}$ across the series resistance. Since R_s is interposed between the headstage and the cell membrane, the actual cell membrane potential will be 10 mV different from the command potential at the headstage. (The direction of the error will depend on the direction of current flow.) Worse, the error will vary as the membrane current varies. In extreme situations in the presence of voltage-gated channels, complete loss of control of membrane potential can occur.
2. **Dynamic voltage errors.** Following a step change in command potential, the actual cell membrane potential will respond with an exponential time course with a time constant given by $\tau_s = R_s C_m$, where C_m is the cell membrane capacitance.

This time constant is 330 μs for the model cell provided with the MultiClamp 700B ($R_s = 10 \text{ M}\Omega$, $C_m = 33 \text{ pF}$). This means that the actual membrane potential response to a step voltage command will have a 10-90% risetime of more than 0.7 ms and will not settle to within 1% of its final value until about 1.5 ms after the start of a step command. If you are interested in fast membrane currents, like sodium currents, this slow relaxation of the voltage clamp is unacceptable.

3. **Bandwidth errors.** The R_s appears in parallel with the membrane capacitance, C_m , of the cell. Together they form a one-pole RC filter with a -3 dB cutoff frequency given by $1/2\pi R_s C_m$. This filter will distort currents regardless of their amplitude. For the parameters of the model cell, this filter restricts true measurement bandwidth to 480 Hz without R_s compensation.

Fortunately, electronic techniques have been developed to partially correct for the errors caused by series resistance. In V-Clamp mode, the techniques are generally referred to as R_s Compensation.

Series resistance errors can also occur in I-Clamp mode. These errors are generally corrected using the techniques of Bridge Balance and Capacitance Neutralization. (See these entries in Chapter 5.)

Is R_s Compensation Necessary?

Before embarking on R_s compensation, it is worth examining whether it is really necessary in your application. The size of R_s can be estimated by selecting the Whole Cell checkbox in the MultiClamp 700B Commander and pressing the Auto button to compensate the whole-cell capacitance. (See Chapter 5, **CAPACITANCE COMPENSATION**.) The estimated R_s is the $M\Omega$ value displayed to the right of the manual adjust button under Whole Cell. If $R_s = 10 M\Omega$ and the maximum membrane current you anticipate is 100 pA, the steady-state voltage error will be at most $10 M\Omega \times 100 \text{ pA} = 1 \text{ mV}$ which is probably insignificant. In this case you might think that R_s compensation is not necessary.

However, it should be remembered that dynamic voltage errors and bandwidth errors can still occur in the above example, because these depend on R_s and C_m and not on the size of the membrane current. Even if you are measuring only small membrane currents in a whole-cell recording, application of R_s compensation can greatly improve the fidelity of the voltage clamp.

As a general rule, it is best to try R_s compensation to see if it makes a difference. This is certainly advisable in all whole-cell recordings. Compensation is rarely useful with isolated membrane patches, which typically have small capacitance and

membrane currents. Indeed, the Whole Cell controls (which must be set before using R_s compensation) are disabled with the 5 and 50 G Ω feedback resistors typically used for isolated patch recordings. An exception is macropatches or nucleated outside-out patches, in which the currents can be quite large and for which R_s compensation may be necessary.

If R_s compensation is found not to be necessary, it is best to turn it off. This is because R_s compensation increases noise.

Adjusting R_s Compensation

It is recommended that you practice adjusting R_s compensation with the PATCH-1U model cell before using compensation in a real experiment. (See Chapter 5, **MODEL CELL**.) Connect the CELL connector to the CV-7 headstage. Set Primary Output to monitor Membrane Current Signal, and increase output Gain to 10. Set the feedback resistor to 500 M Ω (for Voltage Clamp) and Seal Test to 100 mV at 50 Hz. Check the Seal Test checkbox and observe Membrane Current at a fast sweep speed on an oscilloscope, triggering the oscilloscope so you can clearly see the rising edge of the signal (Figure 5.15).

The first step is to fully compensate both the electrode capacitance (using the Cp Fast/Slow controls) and the whole-cell capacitance (using the Whole Cell controls). (See Chapter 5, **CAPACITANCE COMPENSATION**.) The estimated R_s – which is the resistance we wish to compensate – is the $M\Omega$ value displayed under the Whole Cell checkbox. After compensation the trace will look like Figure 5.16.

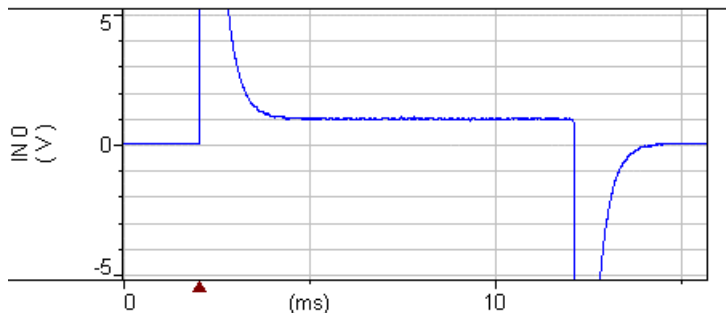

Figure 5.16. Uncompensated response (with saturating transients).

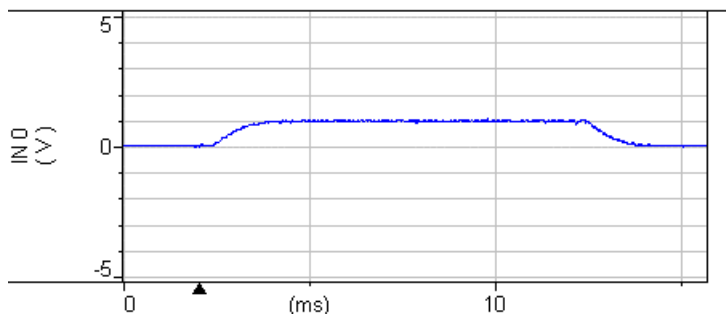

Figure 5.17. After compensating transients.

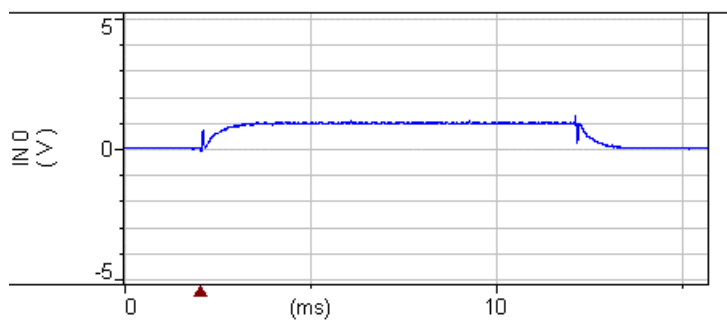

Figure 5.18. After setting Prediction = 90%, Correction = 0%.

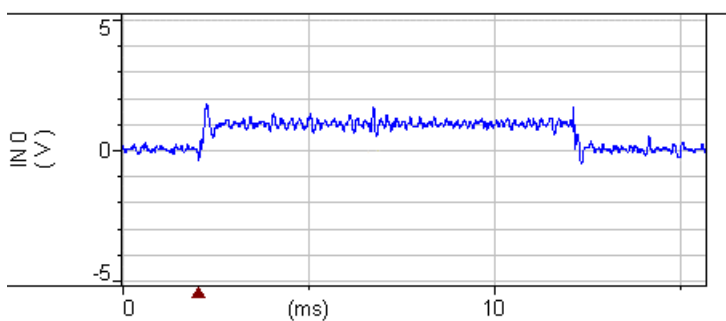

Figure 5.19. After setting Prediction = 90%, Correction = 90%.

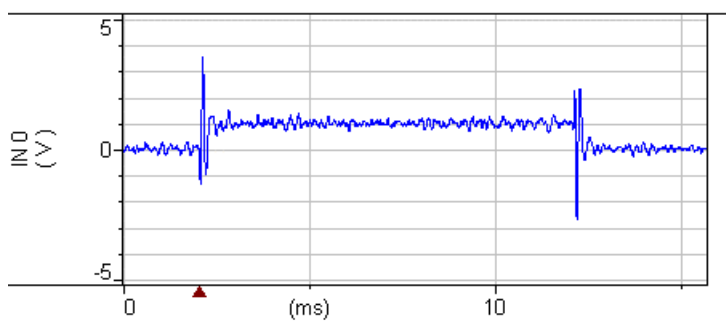



Figure 5.20. After optimizing C_r , R_s and C_m to minimize transients.

Check the R_s Compensation checkbox. If the Prediction and Correction controls are locked together (), press the Lock button to unlock them (). Set R_s Compensation Bandwidth to 15 kHz.

Bandwidth vs. Lag

The MultiClamp 700B R_s Compensation Bandwidth control replaces the “Lag” control on the Axopatch-1D and 200 series amplifiers. The relationship of Bandwidth (BW) to Lag is defined as:

$$\mathbf{BW = 1 / (2 * \pi * Lag)}$$

The default MultiClamp R_s Correction Bandwidth value is 1 kHz, which equates to a Lag value of 160 μ s. (2 kHz BW = 80 μ s Lag, 10 kHz BW = 16 μ s Lag, etc.)

Increase Prediction to 90% (Figure 5.18). Note that Prediction is an open loop process, *i.e.* it does not involve feedback, and instability is only possible if the internal circuitry that develops the prediction signals is pushed too far. Generally, the circuit is stable up to values of about 98%, but it can become non-linear, depending on the magnitude of V_{cmd} . This may only become noticeable after increasing the Primary Output Filter to 50 kHz bandwidth. Reduce Prediction slightly if severe oscillations are observed.

Carefully increase the Correction value to equal that under Prediction. A rather large transient should appear in the current at the beginning and end of the command step. Its peak-to-peak amplitude should be 2-4 nA and it should undergo several distinct “rings” requiring 1 ms to disappear into the noise (Figure 5.19). To eliminate this transient, begin by reducing by a few percent the value of R_s (M Ω) displayed under Whole Cell. As you reduce this setting, the amplitude of the transient first decreases and then begins to increase. A distinct minimum exists and the desired value of R_s is at this minimum.

Next, slightly adjust the C_p Fast settings, trying to further minimize any fast leading-edge transients. When this has been done, small adjustments in the Whole Cell capacitance (pF) value should completely eliminate any remaining transients

(Figure 5.20). If this is not possible in the real experiment, iterative fine adjustments of Cp Fast and Whole Cell R_s may achieve the desired cancellation. If all of this fails and the oscillations are too severe, you may need to go back to the beginning and set the Prediction and Correction controls to lower values.

By reducing the Bandwidth control under R_s Compensation you can usually increase the percent compensation without instability. However, this is likely to be a false improvement if it is pushed too far. Reducing the Bandwidth slows down the feedback circuit used in R_s compensation, reducing its dynamic response. For example, if you limit the Bandwidth to 1 kHz, the R_s Compensation will be reduced substantially for conductance changes faster than 160 μ s. Bottom line: if you increase the Bandwidth value, you can measure faster conductance changes, but you sacrifice R_s compensation stability. One tremendous advantage of the MultiClamp 700B is that you can choose to automatically disable or reduce R_s Compensation if oscillations should occur due to changes in membrane or pipette properties during an experiment (see **Tutorial 5** in Chapter 2).

In order to see the improvement brought about by R_s compensation, check and uncheck the R_s Compensation checkbox. A dramatic speeding-up of the Membrane Current should be apparent with the compensation correctly adjusted.

Theory of R_s Compensation

The MultiClamp 700B uses a dual approach for R_s compensation, like the Axopatch 200 series of amplifiers. This provides superior correction and stability.

For R_s compensation to function properly, whole cell compensation must have been adjusted and the Whole Cell checkbox must be checked. Whole cell compensation provides estimates of R_s and C_m , which together determine the shape of the correction current that is injected through capacitor C2 (Figure 5.20). Note that this C2 correction current does not improve the speed of clamping of the cell; rather, it charges the membrane capacitance as slowly as before but in a way that is invisible to the user, because it bypasses the feedback resistor in the headstage.

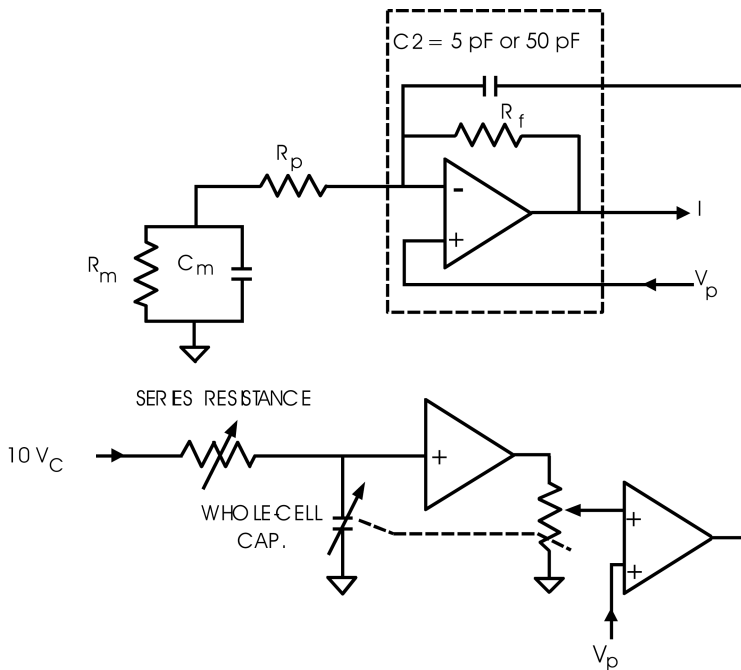

Figure 5.21. Schematic whole-cell compensation circuit.

The ‘Prediction’ Control

After switching on R_s Compensation in the MultiClamp 700B Commander, the Prediction control adds a transient signal to the command potential, speeding the rate at which the true membrane potential will change in response to a step voltage command. It is similar to the idea of “Supercharging” introduced by Armstrong and Chow (1987). The signal added to the command is derived from the command input and from the setting of the Whole Cell compensation parameters. It enables the actual membrane potential to be a faithful replica of the command potential; *i.e.* the effects of series resistance in distorting the command potential at the cell membrane are removed up to the percentage setting of the control (*e.g.* a 98% setting means that, in effect, only 2% of the original series resistance remains in terms of command potential). The signal added by Prediction is injected through the C2 capacitor used by whole cell capacitance compensation (See Figure 5.7). The magnitude and time constant of this signal are determined by the pF and M Ω settings under Whole Cell and by the Prediction setting.

For example, consider a whole-cell voltage clamp situation where $R_s = 10 \text{ M}\Omega$ and $C_m = 50 \text{ pF}$ and the resting membrane resistance R_m is very large with respect to R_s . Assume that Whole Cell pF and M Ω are set at 10 M Ω and 50 pF, respectively, so that the whole-cell capacity transient is perfectly canceled. If the Prediction control is 0%, the signal applied to the headstage capacitor C2 (5 pF for 500M range and 53 pF for 50M range) in response to a step voltage command will have a time constant of 500 μs and an amplitude that is appropriate to cancel a whole-cell capacitance transient arising from these parameters (about 10 V_c). With 0% Prediction nothing is added to the command potential waveform. In response to a step voltage command the cell membrane potential will change to its new value with a time constant of 500 μs ($R_s C_m$). If the % Prediction control is advanced to 50%, a transient will be added to the command potential step, V_c , with a time constant of 250 μs and an amplitude equal to that of the command step itself. This will have the effect of changing the cell membrane potential in response to a step command with a time constant given by $R_s C_m (1 - \% \text{ Prediction} / 100)$; here this is 250 μs .

More formally, the command potential with the Prediction signal included, V_{cp} , can be expressed in terms of the command input, V_c , by:

$$V_{cp} = V_c (1 + s\tau_s) / (1 + s\tau_{srp})$$

where $\tau_s = R_s C_m$, $\tau_{srp} = R_{srp} C_m$, where R_{srp} is the residual (uncompensated) series resistance in terms of Prediction, given by $R_{srp} = R_s (1 - \% \text{ Prediction} / 100)$, and, in the frequency domain $s = j\omega$ (ω is the natural frequency, $\omega = 2\pi f$), or in the time domain s is the operator d/dt . Thus, $V_{cp} = V_c \cdot (1 + (R_s / R_{srp} - 1)e^{-t/\tau_{srp}})$.

Moreover, the membrane potential, V_m , is given by $V_m = V_{cp} / (1 + s\tau_s) = V_c / (1 + s\tau_{srp})$, or $V_m = V_c (1 - e^{-t/\tau_{srp}})$. Therefore, advancing the Prediction setting to 80% gives R_{srp} of 2 M Ω and τ_{srp} of 100 μ s. That is, the speed with which the membrane potential responds to a voltage command is improved 5-fold over that which is achieved with 0% Prediction. Prediction of 98% gives R_{srp} of 200 k Ω and τ_{srp} of 10 μ s. The membrane potential will now respond to a step voltage command with a 10-90% risetime of about 22 μ s and will settle to within 1% of its final value in less than 50 μ s.

Saturation Effects

Note that the equation presented above for V_{cp} (*i.e.* the command potential plus Prediction signal) can be used to define the maximum allowable % Prediction for a given size step voltage command. (This limit should not be confused with limitations imposed by the stability of the Prediction circuit itself.) The command plus Prediction signal is attenuated at the headstage by a 10:1 voltage divider. Since the circuitry in the MultiClamp 700B main unit will saturate at about ± 11 -12 V, V_{cp} is limited in absolute value to about 1.1 to 1.2 V. To be conservative, we will use 1.1 V in the following calculations.

The peak amplitude of V_{cp} for a step voltage command, V_c , is given by $V_c (R_s / R_{srp})$ that can be rewritten as $V_c / (1 - \% \text{ Prediction} / 100)$. So we may state the limitation on V_c as a function of % Prediction as:

$$V_c \leq 1.1(1 - \% \text{ Prediction} / 100)$$

or the limitation on % Prediction as a function of V_c as:

$$\% \text{ Prediction} \leq 100(1 - V_c / 1.1)$$

Thus, for example, if it is known that the maximum command step to be used in a particular experiment is 100 mV, Prediction may be set at 91% without fear of saturation of V_{cp} ; this is true regardless of the value of R_s or C_m . In fact, this is a rather conservative estimate since it is derived on the assumption that the signal V_{cp} will instantly jump to its maximum value following a step voltage command. In fact, due to limitations in the speed of the Prediction circuitry, this over-estimates the maximum value of V_{cp} , particularly when % Prediction is large. In actual practice, Prediction can typically be set to about 94% for a 100 mV command step.

Readjustment of Whole Cell Compensation with ‘Prediction’

As the Prediction potentiometer is advanced, the signal applied to the headstage capacitor C2 is modified appropriately so that it will continue to cancel the whole-cell capacity transient despite the fact that the speed of this transient has increased. This is simply accomplished by reducing the time constant of this signal as % Prediction is increased. If the circuitry worked perfectly, and if the whole-cell capacity transient had been perfectly canceled with 0% Prediction, no transient would appear as % Prediction is increased up to the maximum allowable values. However, due to the complexity of this circuitry and a variety of non-ideal characteristics, cancellation of whole-cell capacity transients does not remain perfect as % Prediction is increased. The small residual transient that emerges can, however, be completely removed by small readjustments of the setting of the Cp Fast and Whole Cell controls. (See “Adjusting R_s Compensation”, above.)

It should be noted that Prediction would work for any command waveform, not just steps. This may be useful for capacitance measurements using phase sensitive techniques or lock-in amplifiers.

The ‘Correction’ Control

Although Prediction can greatly speed the response time of the true membrane potential with respect to the command potential and, thus, overcome one important effect of series resistance, it does not correct for the effects of series resistance associated with the flow of membrane ionic current (*i.e.* IR drops and filtering effects described above). This is the role of the % Correction value. Correction feeds back a portion of the measured membrane current; this signal is added to the command potential. The percentage set by the Correction potentiometer refers to the R_s ($M\Omega$) value under Whole Cell. For example, if this value is $10 M\Omega$, a 90% setting of the Correction control means that $9 M\Omega$ of series resistance is compensated; the residual (uncompensated) series resistance in terms of Correction, R_{src} , is $1 M\Omega$.

The Bandwidth setting under R_s Compensation gives the -3 dB cutoff frequency of a one-pole RC filter through which the Correction signal is passed prior to being summed with V_c . The Bandwidth is used to ensure stability when large amounts of Correction are used. It is generally good practice to begin using Correction with the Bandwidth set at 10 kHz or less. However, once the desired level of Correction has been achieved, it is usually possible (if desired) to significantly increase the Bandwidth setting; 30 kHz is usually quite achievable for 90% Correction.

Continuing with the example considered above ($R_s = 10 M\Omega$, $C_m = 50$ pF), a 90% Correction setting will reduce voltage errors in the true membrane potential resulting from the flow of ionic current to 10% of the error present with 0% Correction. For example, a 2 nA ionic current would produce a 20 mV error in V_m with 0% Correction, whereas 90% Correction will reduce this error to only 2 mV. At the same time, the use of Correction will reduce the filtering effect of R_s and C_m on the measured current. With 0% Correction the actual bandwidth of current measurement prior to any output filtering is limited to $1/2\pi R_s C_m$, which will be about 320 Hz in this example. As % Correction is increased this “filter” changes to $1/2\pi R_{src} C_m$, so that for 90% Correction the possible bandwidth for current measurement is increased to 3.2 kHz in this example. With 95% Correction the possible bandwidth is increased to 6.4 kHz and with 98% it is further increased to 16 kHz (although the effects of the Bandwidth value should not be forgotten).

Readjustment of Whole Cell Compensation with ‘Correction’

If the capacity transient has been canceled prior to the use of Correction (and for now assume that Prediction has already been set at 95%) then, in principle, there is no capacity current to feed back when Correction is utilized. Note that the discussion here of capacity current should be distinguished from the discussions of the ionic current. Therefore, no transient should develop as Correction is advanced. In practice, however, a small transient will emerge as % Correction is increased. Again, this is due to non-ideal characteristics of the circuitry. As in the case of ‘Prediction’, the small residual transient that emerges can be completely removed by small readjustments of the setting of the Cp Fast and Whole Cell controls. (See “Adjusting R_s Compensation”, above.)

Setting ‘Prediction’ and ‘Correction’ Values

There are many situations in which it will be desirable to have the % Prediction and the % Correction controls set at different values. For example, for a 200 mV step command Prediction should be limited to about 80% to avoid saturation. (See “Saturation Effects”, above.) However, it is usually possible to compensate series resistance up to 90 to 95% or more by use of the Correction control. In other patch clamps the issue of saturation would limit the amount of compensation used for ionic currents; this is not true in the MultiClamp 700B. On the other hand, in some cases it might be impossible to advance the Correction percentage beyond about 70% without causing instability. Nevertheless, Prediction, which is inherently stable up to 98% or more, can be set to a value substantially higher than 70% (about 95%), thereby ensuring that the true transmembrane potential changes rapidly in response to the command potential even though a substantial series resistance remains uncompensated in terms of ionic currents.

Oscillations

One of the practical problems when using the % Correction function of R_s Compensation is that there is a great risk of oscillations because the Correction circuitry is a form of positive feedback. The main cause of oscillations is the

inability of the circuitry to distinguish between current that flows down the electrode and into the cell from current that flows through the stray capacitance of the electrode into the bath. The current that flows through the electrode resistance into the cell is the current that is intended to be compensated. The Correction circuitry also tries to compensate for the current into the electrode capacitance. However, in this case there is no significant series resistance component to compensate, and the Correction circuit will oscillate as soon as the Correction control is advanced.

The tendency to oscillate therefore depends on the relative magnitude of the electrode resistance to the electrode capacitance and the degree of compensation of the electrode capacitance. Thus, one should take care that C_m is well compensated as one advances correction. In addition, the tendency to oscillate can be reduced by limiting the bandwidth of the positive-feedback circuit. This is the function of the Bandwidth control.

Limitations of R_s Compensation

Series-resistance compensation is an attempt to electronically reduce the effect of the electrode resistance. Because of practical limitations, it is never perfect. Even if 100% compensation could be used with stability, this would only apply to DC and medium-speed currents. Very fast currents cannot be fully corrected.

For best results, the cell membrane resistance should be many-fold higher than the electrode resistance. This is normally the case for cells at rest containing small drug-activated or synaptic currents. However, during voltage activation the cell membrane resistance could fall a hundredfold or more to values similar to or less than the series resistance. In these cases it is probable that:

1. There will be a significant error due to the voltage drop across the electrode. This error is not obvious to the user because the patch clamp controls the combined voltage drop across the electrode and the cell.
2. The setting of the Whole Cell compensation controls will become erroneous because it is based on the time constant to charge the membrane

capacitance before the change in membrane resistance occurred. Since this time constant depends on the parallel value of membrane resistance and the electrode series resistance, this error could become substantial.

If the cell input resistance becomes comparable to, or less than, the electrode resistance, the whole-cell patch clamp technique will probably not work. In this situation it would be preferable to use a discontinuous (chopped) single-electrode voltage clamp, such as the Axoclamp.

SoftPanel Configuration

The SoftPanel is an optional instrument that provides knob and button control in place of mouse gliders and clicks in the MultiClamp 700B Commander software. The SoftPanel is merely a hardware extension of the Commander, and replicates the many Commander control functions of the MultiClamp 700B.

The SoftPanel comes with a magnetic overlay with pre-defined functions assigned to the various knobs and buttons. However, the SoftPanel can easily be re-configured in the MultiClamp 700B Commander software. Click on the Configure SoftPanel toolbar icon () to access the menus for re-configuring each knob or button.

After assigning the desired functions to each knob or button, remove the pre-defined magnetic overlay to reveal the erasable surfaces at each knob or button. Re-label the position with the appropriate function using a marking pen. (Sharpie® pens are appropriate on this special surface.)

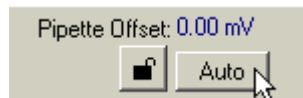

Figure 5.22

Status

- STATUS light on the front panel of the MultiClamp 700B indicates traffic on the USB cable.
- See also Chapter 6, **TROUBLESHOOTING**.

The STATUS light illuminates whenever data is being transmitted on the USB cable that connects the MultiClamp 700B to the host computer. Under quiescent conditions the STATUS light flashes at about 2 Hz, indicating that the MultiClamp 700B Commander is interrogating the MultiClamp 700B in order to update its meter displays.

The STATUS light is useful for troubleshooting. If it does not flash continuously, a communication problem is indicated. (See **TROUBLESHOOTING**.)

Zap

- Zap applies a large, brief voltage pulse to the electrode when in V-Clamp mode, to facilitate breaking into a cell for whole-cell recording.
- Zap is triggered by pressing the **Zap** button in the V-Clamp pane.

The conventional method for rupturing a membrane patch to go to whole-cell recording is to apply a pulse of suction. Sometimes this method damages the cell. Zap provides an alternative method. It applies a large (1 V) voltage pulse that ruptures the patch, presumably by causing dielectric breakdown of the membrane. The Zap duration can be varied; it is best to use the minimum duration that is likely to achieve the desired result, because too long a Zap could cause the seal resistance to deteriorate. A duration of 0.5 or 1 ms is suggested for initial attempts.

Apply a repetitive test pulse (*e.g.* Seal Test) and press the Zap button while carefully monitoring Membrane Current. Sometimes it helps to apply steady suction while Zapping. Successful break-through is signaled by an increase in the current noise and by large whole-cell capacitance transients.

Chapter 6

Troubleshooting

It has been our experience at Axon Instruments that the majority of troubles reported to us have been caused by faulty equipment connected to our instruments.

If you have a problem, please physically disconnect *all* instruments connected to the MultiClamp 700B except for the oscilloscope. Ideally, remove the MultiClamp 700B from the rack. Work through Chapter 2, **INSTALLATION AND BASIC OPERATION**. This can often uncover a problem that is in your setup. In order to force the MultiClamp 700B Commander to recheck the hardware configuration, press the Select Device button in the toolbar. (See Chapter 5, **SELECT DEVICE**.)

Some common problems are listed below.

Symptom: The MultiClamp 700B is not responding to commands. The Status light is not flashing.

Possible causes: The USB cable is not plugged in properly or is defective. The PC's USB port is defective. Select Device has been set to Demo rather than MultiClamp Hardware, or the correct Device Number has not been set.

Suggestions: Check the USB cable. Check that the PC's USB port works with other serial instruments, or try a different port. Press the Scan button in the Select Device window to ensure that the MultiClamp 700B Commander can find the correct device.

Symptom: Unable to adjust the Pipette Offset to zero.

Possible causes: There may be a break in the connection between the headstage input and ground, causing the input to float. The bath may be leaking, producing a short circuit to the microscope. In I-Clamp mode, the capacitance neutralization circuit may be oscillating.

Suggestions: Check the electrical continuity and DC stability of the electrode holder and bath electrode. Check for bubbles in the microelectrode. Check that the outside of the chamber is dry. Set Pipette Capacitance Neutralization to zero.

Symptom: Extraneous noise is present in the Primary Output signal. Pipette Offset is drifting rapidly.

Possible cause: The Ag/AgCl pellet or Ag wire in the electrode holder may be defective. Dirt or corrosion may have built up in the holder or headstage connector socket.

Suggestions: Check the DC stability of the pellet and replace if necessary. Rechloride the Ag wire. Clean the holder and headstage connectors.

If the problem cannot be resolved, please contact Axon Instruments for technical support (1-800-635-5577 or axontech@axon.com).

Chapter 7

Specifications

Unless otherwise specified, $T_A = 20^\circ\text{C}$, 1 hr warm-up time.

Main Unit

Line Voltage 85 - 260V

Line frequency 50 - 60 Hz

Fuse 5 mm x 20 mm 2A slow

Case 8.89 cm high x 48.26 cm x 30.48 cm deep (3.5" x 19" x 12" deep) rack mountable

CV-7 Headstage

Dimensions 4.06 x 8.38 x 2.03 cm (1.6" x 3.3" x 0.8")

Voltage Clamp

Gain: $R_f = 50\text{ G}\Omega$, 5 G Ω , 500 M Ω , 50 M Ω

| | | |
|--------------------------------------|-------|------------|
| 10 kHz Noise (8-pole Bessel filter): | 50 G | 0.28 pArms |
| | 5 G | 0.9 pArms |
| | 500 M | 1.4 pArms |
| | 50 M | 3.0 pArms |

| | | |
|--|-------|------------|
| 5 kHz Noise (4-pole Butterworth filter): | 50 G | 0.15 pArms |
| | 5 G | 0.5 pArms |
| | 500 M | 0.8 pArms |
| | 50 M | 2.0 pArms |

Fast capacitance compensation magnitude:

0 - 12 pF for 50 G range.

0 - 36 pF on all other ranges.

Fast capacitance compensation tau:

0.5 μ s to 1.8 μ s.

Slow capacitance compensation magnitude:

0 - 1 pF for 50 G range.

0 - 3 pF on all other ranges.

Slow capacitance compensation tau:

10 μ s to 10 ms in two ranges (10 – 200 μ s and 200 – 4000 μ s).

Whole cell capacitance compensation:

C_m from 1 pF to 100 pF and R_s from 400 k to 1000 M on 500 M range.

C_m from 2.5 pF to 1000 pF and R_s from 100 k to 100 M on 50 M range.

Series Resistance compensation:

Bandwidth is adjustable from 0.32 to 16 kHz.

Series resistances corrected varies from 0.4 to 1000 M on 500 M range and

0.1 to 100 M on 50 M range.

Current Clamp

Rise time < 10 μ s for load of 10 M on 50 M range (Output Filter bypassed).

Rise time < 30 μ s for load of 100 M on 500 M range.

Rise time < 150 μ s for load of 1 G on 5 G range.

Test Signals

Voltage Clamp

The available test signals are Seal Test, Pulse and Zap.

Seal Test and Pulse amplitudes are selectable from 0 to ± 1 V at the electrode.

Seal Test frequency is selectable from 2 to 1000 Hz.

Pulse duration is selectable from 0.1 to 500 ms.

Zap is fixed at +1V at the electrode but with selectable 0.1 to 50 ms duration.

Current Clamp

The available test signals are Tune, Pulse, Buzz and Clear (+/-).

Tune and Pulse amplitudes are selectable from 0 to ± 10 V/ R_f amps at the electrode.

Tune frequency is selectable from 2 to 1000 Hz.

Pulse duration is selectable from 0.1 to 500 ms.

Buzz amplitude is fixed at ± 15 V signal to the headstage capacitor but with selectable 0.05 to 500 ms duration.

Clear (+/-) amplitude is fixed at ± 15 V signal to the headstage capacitor.

DC Holding Commands

Voltage Clamp

± 1000 mV range in 30 μ V steps

Auto Pipette Offset adjusts DC holding potential to zero Membrane Current.

Current Clamp

± 20 nA range in 0.7 pA steps (50 M Ω range)

± 2 nA range in 0.07 pA steps (500 M Ω range)

± 0.2 nA range in 0.007 pA steps (5 G Ω range)

Note: External command can provide up to 10 times the above holding currents.

Auto Pipette Offset adjusts DC holding current to zero Membrane Potential.

Output Gain and Filters

Output Gain

Primary: Post-filter gain of 1, 2, 5, 10, 20, 50, 100, 200, 500, 1000, 2000.

Secondary: Post-filter gain of 1, 2, 5, 10, 20, 50, 100.

Primary Output Filters

Lowpass four-pole Bessel frequencies (Hz): 2, 4, 6, 8, 10, 12, 14, 16, 18, 20, 22, 24, 26, 28, 30, 40, 60, 80, 100, 120, 140, 160, 180, 200, 220, 240, 260, 280, 300, 400, 600, 800, 1k, 1k2, 1k4, 1k6, 1k8, 2k, 2k2, 2k4, 2k6, 2k8, 3k, 4k, 6k, 8k, 10k, 12k, 14k, 16k, 18k, 20k, 22k, 24k, 26k, 28k, 30k, Bypass.

Lowpass four-pole Butterworth frequencies (Hz): 3, 6, 9, 12, 15, 18, 21, 24, 27, 30, 33, 36, 39, 42, 45, 60, 90, 120, 150, 180, 210, 240, 270, 300, 330, 360, 390, 420, 450, 600, 900, 1k2, 1k5, 1k8, 2k1, 2k4, 2k7, 3k, 3k3, 3k6, 3k9, 4k2, 4k5, 6k, 9k, 12k, 15k, 18k, 21k, 24k, 27k, 30k, 33k, 36k, 39k, 42k, 45k, Bypass.

Highpass single-pole Bessel frequencies (Hz): DC, 0.1, 1, 3, 10, 30, 100, 300.

Secondary Output Filters

Lowpass single-pole Bessel filter fixed at 10 kHz frequency, or Bypass.

Scope Filter

Lowpass two-pole Bessel filter with four -3 dB cutoff frequencies (Hz): 1k, 3k, 10k, Bypass.

Command Inputs

20 mV/V or 100 mV/V sensitivity for V-Clamp;

400 pA/V or 2 nA/V sensitivity for I-Clamp.

Input impedance is 10 k Ω .

Mode Switching

External

When enabled in MultiClamp 700B Commander software, 0 V input to MODE BNC selects I-Clamp mode and 5 V input selects V-Clamp mode. This mode can be used in conjunction with Internal Auto Mode switching to return mode to I-Clamp (see Internal Mode Switching).

Internal

When enabled in MultiClamp 700B Commander Options / Auto menu, switch from I-Clamp to V-Clamp is automated when V_m threshold crossing is detected.

- Positive to Negative or Negative to Positive crossing
- V_m threshold: ± 1000 mV
- Delay to switch: 0-500 ms, in 2 ms steps
- Delay to return from V-Clamp: 20ms – 500 seconds, in 10 ms steps
(this can also be done manually or with External Mode BNC)

Switching Speeds

Auto, from I-Clamp to V-Clamp: < 0.5 ms

Auto, from V-Clamp to I-Clamp: ≈ 22 ms

Mode switching performed manually with the mouse, keyboard or SoftPanel interface will always be slower than automatic switching, due to delays in computer operating system communication. Add approximately 30 msec to the above speeds to estimate typical manual switching speeds.

Audio Monitor

The Audio Monitor output can select Current, Voltage or Voltage x 100 for either Channel 1 or Channel 2. The selected signal is available for direct monitoring or via a voltage-to-frequency converter (VCO). The VCO ranges from ~ 4000 Hz @ +100 mV to ~ 300 Hz at -100 mV.

References

Armstrong, C.M. and Chow, R.H. Supercharging: a new method for improving patch-clamp performance. *Biophys. J.* **52**:133-136, 1987.

Ebihara, S., Shirato, K., Harata, N. and Akaike, N. Gramicidin-perforated patch recording: GABA response in mammalian neurones with intact intracellular chloride. *J. Physiol.* **484**:77-86, 1995.

Cota, G. and Armstrong, C.M. Potassium channel “inactivation” induced by soft-glass patch pipettes. *Biophys. J.* **53**:107-109, 1988.

Finkel, A.S. and Redman, S.J. Optimal voltage clamping with a single microelectrode. In: Voltage and Patch Clamping with Microelectrodes, Smith, T.G., Lecar, H., Redman, S.J., Gage, P.W. (Eds), Williams & Wilkins: Baltimore, 1985.

Furman, R.E. and Tanaka, J.C. Patch electrode glass composition affects ion channel currents. *Biophys. J.* **53**: 287-292, 1988.

Hamill, O.P., Marty, A., Sakmann, B. and Sigworth, F.J. Improved patch-clamp techniques for high-resolution current recording from cells and cell-free membranes patches. *Pflügers Arch.* **391**: 85-100, 1981.

Johnston, D. and Brown, T.H. Interpretation of voltage-clamp measurements in hippocampal neurons. *J. Neurophysiol.* **50**:464-486, 1983.

Purves, R.D. Microelectrode Methods for Intracellular Recording and Ionophoresis. Academic Press: London, 1981.

Rae, J., Cooper, K., Gates, P. and Watsky, M. Low access resistance perforated patch recordings using amphotericin B. *J. Neurosci. Meth.* **37**:15-26, 1991.

Sakmann, B. and Neher, E. Single-Channel Recording. (Second Edition) Plenum Press: New York, 1995.

Sherman-Gold, R. The Axon Guide for Electrophysiology & Biophysics Laboratory Techniques. Axon Instruments, Foster City, CA. 1993. *Available at* <http://www.axon.com>

Yawo, H. and Chuhma, N. An improved method for perforated patch recordings using nystatin-fluorescein mixture. *Jap. J. Physiol.* **43**:267-273, 1993.

Technical Assistance

If you need help to resolve a problem, there are several ways to contact Axon Instruments / Molecular Devices:

World Wide Web

www.axoninstruments.com

Phone

1 (800) 635-5577

Fax

+1 (62:) 969-3922

E-mail

axon@axoninstruments.com

Questions?

See our Knowledge Base: <http://www.axoninstruments.com/knowledgebase>

Warranty and Repair Service

Warranty

Axon Instruments / Molecular Devices Corp. warrants its non-consumable hardware products to be free from defects in materials and workmanship for 12 months from date of invoice. The warranty covers the cost of parts and labor to repair the product. Products returned to our factory for repair must be properly packaged with transportation charges prepaid and the shipment fully insured. Axon Instruments / Molecular Devices will pay for the return shipping of the product to the customer. If the shipment is to a location outside the United States, the customer will be responsible for paying all duties, taxes and freight clearance charges if applicable.

The warranty is valid when the product is used for its intended purpose and does not cover products which have been modified without approval from Axon Instruments, or which have been damaged by abuse, accident or connection to incompatible equipment.

To obtain warranty service, follow the procedure described in the Repair Service section. Failure to do so will cause long delays and additional expense to the customer.

This warranty is in lieu of all other warranties, expressed or implied.

Repair Service

The company reserves the right to cease providing repair maintenance, parts and technical support for its non-consumable hardware products five years after a product is discontinued. Technical support for old versions of software products will cease 12 months after they are upgraded or discontinued.

If you purchased your instrument from a Distributor or OEM Supplier, contact them for repair service.

If you purchased your instrument from Axon Instruments / Molecular Devices, contact our Technical Support Department. If it is determined your instrument must return to the factory for repair, the Technical Support Representative will issue a Service Request (SR) number. Our Logistic Coordinator will contact you with specific instructions.

Shipping

The MultiClamp 700B is a solidly built instrument designed to survive shipping around the world. However, in order to avoid damage during shipping, the MultiClamp 700B must be properly packaged.

In general, the best way to package the MultiClamp 700B is in the original factory carton. If this is no longer available, we recommend that you carefully wrap the MultiClamp 700B in at least three inches (75 mm) of foam or "bubble-pack" sheeting. The wrapped instrument should then be placed in a sturdy cardboard carton. Mark the outside of the box with the word FRAGILE and an arrow showing which way is up.

We do NOT recommend using loose foam pellets to protect the MultiClamp 700B. During shipping, there is good chance that the instrument will shift within the loose pellet packing and be damaged.

If you need to ship the MultiClamp 700B to another location, or back to the factory, and you do not have a means to adequately package it, Axon Instruments /

Molecular Devices can ship the proper packaging material to you for a small fee. This may seem an expense you would like to avoid, but it is inexpensive compared to the cost of repairing an instrument that has sustained shipping damage.

It is your responsibility to package the instrument properly before shipping. If the packaging is inadequate, and the instrument is damaged during shipping, the shipper will not honor your claim for compensation.

Declaration of Conformity

Manufacturer: Axon Instruments / Molecular Devices
3280 Whipple Road
Union City, CA 94587
USA

Type of Equipment: Computer-Controlled Microelectrode Amplifier

Model Number: MultiClamp 700B

Year of Manufacture: 2003

Application of Council Directives:

EC EMC Directive 89/336/EEC as amended

EC Low Voltage Directive 73/23/EEC as amended

Harmonized Standards to which Conformity is Declared:

EMC: EN 61326-1: 1997 (A1: 1998 A2: 2001)

EN 55011/CISPR11: 1998 AS/NZS 2064: 1997

Safety: EN 61010-1: 2001

I, the undersigned, hereby declare that the equipment specified above conforms to the above Directives and Standards.

Authorized Signature and Date: _____ (Signature on file)



Important Safety Information

DISCLAIMER

THIS EQUIPMENT IS NOT INTENDED TO BE USED AND SHOULD NOT BE USED IN HUMAN EXPERIMENTATION OR APPLIED TO HUMANS IN ANY WAY.

WARNING

IF THIS EQUIPMENT IS USED IN A MANNER NOT SPECIFIED BY THE MANUFACTURER, THE PROTECTION PROVIDED BY THE EQUIPMENT MAY BE IMPAIRED.

Power-Supply Voltage Selection and Fuse Changing

Supply Voltage

The MultiClamp 700B can be directly connected to all international supply voltages. The input range is from 100 to 240 V \sim . No range switching is required. Alternatively, the instrument can be powered by a DC voltage of 120 to 310 V.

Changing the Fuse

The MultiClamp 700B uses a 250 V \sim , T2A, 5 x 20 mm fuse.

In the event of fuse failure, disconnect the power cord.

Before changing the fuse investigate the reason for its failure.

To change the fuse:

1. Disconnect the power cord.
2. Use a screwdriver or a similar device to rotate the fuse holder counterclockwise.
3. Replace the fuse with another fuse of the same rating.
4. Reconnect the power cord.

Basic Equipment Setup and Safety

1. Connections: Use the included IEC power cord to connect the instrument to a GROUNDED power receptacle.
2. Mounting: Table or rack.
3. Assembly: The headstage connects to the instrument through the rear panel, 25 pin D-sub connector marked "Headstage". Power should always be turned OFF when connecting headstages to the main unit.
4. Use: Do not operate this equipment with covers or panels removed.
5. Cleaning: Wipe the headstage connector with a damp cloth to clean salt spills. Avoid spilling liquids on the headstage.

The Teflon input connector should be kept very clean. Effective cleaning can be done by swabbing carefully with denatured alcohol or deionized water. If possible, avoid the use of Freon since it is thought to be detrimental to the environment.

Safe Environmental Conditions

1. Indoor use.
2. Mains supply fluctuations: not to exceed $\pm 10\%$ of the nominal voltage.
3. Temperature: between 5 °C and 40 °C.
4. Altitude: up to 2000 m.
5. This instrument is designed to be used under laboratory conditions. Operate in a clean, dry environment only. Do not operate in a wet or damp environment.

Static Precautions

If you are in a laboratory where static is high (*i.e.*, you hear and feel crackles when you touch things), you should touch a grounded metal object immediately before touching the headstage.

Shipping the MultiClamp 700B

The MultiClamp 700B is a solidly built instrument designed to survive shipping around the world. However, in order to avoid damage during shipping, the MultiClamp 700B must be properly packaged.

In general, the best way to package the MultiClamp 700B is in the original factory carton. If this is no longer available, we recommend that you carefully wrap the MultiClamp 700B in at least three inches (75 mm) of foam or "bubble-pack" sheeting. The wrapped MultiClamp 700B should then be placed in a sturdy cardboard carton. Mark the outside of the box with the word FRAGILE and an arrow showing which way is up.

We do not recommend using loose foam pellets to protect the MultiClamp 700B. If the carton is dropped by the shipper, there is a good chance that the MultiClamp 700B will shift within the loose pellet packaging and be damaged.

If you need to ship your MultiClamp 700B to another location, or back to the factory, and you do not have a means to adequately package it, Axon Instruments can ship the proper packaging material to you for a small fee. This may seem like an expense you would like to avoid, but it is inexpensive compared to the cost of repairing an instrument that has sustained shipping damage.

It is your responsibility to package the instrument properly before shipping. If it is not, and it is damaged, the shipper will not honor your claim for compensation.

Renseignements Importants

LIMITE DE RESPONSABILITE

CE MATERIEL N'A PAS ETE CONCU POUR DES EXPERIENCES SUR LES ETRES HUMAINS; ET NE DOIT DONC PAS ETRE UTILISE A CETTE FIN.

ATTENTION

L'EMPLOI DE CE MATERIEL D'UNE MANIERE DIFFERENTE A CELLE SPECIFIEE PAR LE FABRICANT AFFECTERA LE NIVEAU DE PROTECTION FOURNI PAR L'APPAREIL.

Sélection du voltage et changement du fusible

Voltage d'alimentation

Le MultiClamp 700B peut être directement branché sur toutes alimentations comprises entre 100 et 240 V~. Aucun changement n'est nécessaire afin de sélectionner le voltage de l'appareil. En outre, l'appareil peut être aussi alimenté en courant continu (DC) de 120 à 310 V.

Changement du fusible

Le MultiClamp 700B emploie un fusible de 250 V~, T2A, 5 × 20 mm.

En cas de rupture du fusible, débrancher la prise de courant.

Avant de changer le fusible, chercher la raison de la panne.

Pour changer le fusible:

1. Débrancher la prise de courant.
2. A l'aide d'un tournevis ou autre outil de ce genre, faire tourner le support du fusible dans le sens opposé des aiguilles d'une montre.
3. Remplacer le fusible par un fusible de même valeur.
4. Rebrancher la prise de courant.

Installation du matériel et sécurité

1. Branchement: Employer le fil électrique IEC fourni pour brancher l'appareil à une prise de courant comprenant UNE TERRE.
2. Pose: Table ou rack.
3. Montage: La tête de l'amplificateur ("headstage") est connectée à l'appareil sur le panneau arrière, par l'intermédiaire d'une prise D-sub à 25 fiches portant l'indication "Headstage".
4. Emploi: Ne pas utiliser ce matériel sans son couvercle et ne pas le couvrir lors de son utilisation.
5. Nettoyage: Essuyer la prise du "headstage" avec un linge humide pour nettoyer les traces de sel. Éviter de renverser des liquides sur le "headstage".

La prise d'entrée en Téflon doit être maintenue très propre. Un nettoyage efficace consiste à vaporiser de l'alcool ou à essuyer soigneusement avec de l'eau désionisée. Si possible, éviter l'emploi de Fréon, ce produit étant considéré comme nuisible pour l'environnement.

Conditions à respecter pour un emploi sans danger

1. Emploi à l'intérieur.

2. Fluctuations du réseau d'alimentation: ne doivent pas dépasser $\pm 10\%$ de la tension nominale.
3. Température: entre 5 °C et 40 °C.
4. Altitude: jusqu'à 2000 m.
5. Cet appareil a été étudié pour l'emploi en laboratoire et il doit être situé dans un environnement sec et propre. Ne pas l'utiliser dans un environnement mouillé ou humide.

Précautions statiques

Le "headstage" peut être manié sans danger. Cependant, dans un laboratoire avec un niveau élevé d'électricité statique (c'est-à-dire lorsque vous sentez et voyez des décharges électriques), touchez un objet métallique pour une mise à la terre avant de toucher le "headstage".

Ne pas débrancher le MultiClamp 700B lors de la manipulation de l'entrée du "headstage", ceci risque de déranger son équilibre thermique.

Expédition du MultiClamp 700B

Le MultiClamp 700B est un appareil de construction robuste, étudié en vue d'expéditions dans le monde entier. Cependant, l'appareil doit être correctement emballé pour éviter tout dommage pendant son transport.

En général, la meilleure façon d'emballer le MultiClamp 700B est de le mettre dans son carton d'origine. Si celui-ci n'est plus disponible, il est recommandé d'envelopper soigneusement le MultiClamp 700B dans au moins trois inches (75 mm) de mousse ou de feuilles d'emballage à bulles. Le MultiClamp 700B ainsi protégé devra alors être placé dans un carton solide. Indiquer la mention FRAGILE sur l'extérieur de la boîte ainsi qu'une flèche vers le haut montrant la position verticale.

Il n'est pas recommandé d'employer des boulettes de mousse pour protéger le MultiClamp 700B. En cas de chute de la boîte durant son transport, le MultiClamp 700B pourrait se déplacer à l'intérieur et être endommagé.

Si vous devez expédier le MultiClamp 700B à un autre endroit, ou le renvoyer au fabricant, et si les matériaux d'emballage nécessaires corrects ne sont pas disponibles, ces derniers peuvent être obtenus chez Axon Instruments pour un prix minime. Bien que ceci puisse sembler être une dépense que vous pourriez éviter, elle est cependant insignifiante en comparaison à celle que coûterait la réparation d'un appareil endommagé pendant le transport.

La responsabilité vous incombe de bien emballer l'appareil avant son expédition. Si ceci n'est pas fait, le transporteur ne pourra pas satisfaire vos réclamations de compensation en cas d'avaries.

Wichtige Informationen

UNZULÄSSIGE VERWENDUNG

DIESER APPARAT IST NICHT VORGESEHEN, BEI MENSCHLICHEN VERSUCHEN VERWENDET ZU WERDEN UND AUCH NICHT AN MENSCHEN IN IRGENDWEISE ANWENDBAR.

WARNUNG

WEN DIESER APPARAT IN EINER ART UND WEISE ANGEWENDET WIRD, DIE NICHT VOM HERSTELLER SPEZIFISCH ERWÄHNT WIRD, KANN DIE SCHUTZVORRICHTUNG DES APPARATES BEEINTRÄCHTIGT WERDEN.

Spannungswahl für die Stromversorgung und Auswechseln der Sicherung

Netzspannung

Der MultiClamp 700B kann direkt an alle internationalen Netzspannungen angeschlossen werden. Die Eingangsspannung reicht von 100 bis 240 V~. Ein Umschalten des Spannungsbereichs ist nicht erforderlich. Das Instrument kann auch mit Gleichstromspannungen von 120 bis 310 V betrieben werden.

Auswechseln der Sicherung

Der MultiClamp 700B verwendet eine 250V~, T2A, 5 x 20 mm Sicherung.

Im Falle des Ausfalls der Sicherung das Netzkabel ausschalten.

Vor dem Auswechseln der Sicherung den Grund für ihren Ausfall untersuchen.

Schritte zum Auswechseln der Sicherung:

1. Das Netzkabel ausschalten.
2. Die Fassung der Sicherung mit einem Schraubenzieher oder einem ähnlichen Werkzeug entgegen dem Uhrzeiger drehen.
3. Die Sicherung mit einer anderen Sicherung mit gleicher Nennleistung ersetzen.
4. Das Netzkabel wieder anschließen.

Grundlegende Hinweise zu Installation und Sicherheit der Ausrüstung

1. Netz- und Erdungsanschlüsse: Das Instrument mit dem beigefügten IEC Netzkabel an einen Erdungsschalter anschließen.
2. Anbringung: Tisch oder Rahmengestell.
3. Montage: Der Vorverstärker ("headstage") wird über einen mit der Aufschrift "Headstage gekennzeichneten 25 Pin D-Unterstecker an der Rückwand des Instrumentes verbunden.
4. Gebrauch: Dieser Apparat darf nicht mit abgenommenen Abdeckungen oder Platten in Betrieb gesetzt werden.
5. Reinigung: Zur Reinigung von verschüttetem Salz den Vorverstärkeranschluß mit einem feuchten Tuch abwischen. Das Verschütten von Flüssigkeiten auf den "headstage" ist zu vermeiden.

Der Teflon-Eingangsstecker sollte in sehr sauberem Zustand gehalten werden. Durch Besprühen mit Alkohol oder vorsichtigem Abtupfen mit entionisiertem Wasser ist eine wirksame Reinigung möglich. Die Benutzung von Freon ist nach Möglichkeit zu vermeiden, da diese Substanz als umweltschädigend angesehen wird.

Umweltsichere Betriebsbedingungen

1. Verwendung in Innenräumen.
2. Netzschwankungen: darf nicht $\pm 10\%$ der Nennspannung überschreiten.
3. Temperatur: zwischen 5 °C und 40 °C.
4. Höhe: bis zu 2000 m.
5. Dieses Instrument ist für den Gebrauch unter Laborbedingungen vorgesehen. Nur in sauberer, trockener Umgebung in Betrieb setzen. Nicht in nasser oder feuchter Umgebung in Betrieb setzen.

Schutzmaßnahmen gegen statische Aufladung

Der "headstage" kann normalerweise sicher gehandhabt werden. Falls Sie sich jedoch in einem Labor mit höher statischer Aufladung befinden (*D.h.* Sie hören und fühlen beim Berühren von Objekten ein Knacken), sollten Sie unmittelbar vor dem Berühren der "headstage" ein geerdetes Objekt aus Metall anfassen.

Bei Handhabung des Vorverstärkereingangs sollten Sie die Stromzufuhr zum MultiClamp 700B *nicht* abschalten, um das Temperaturgleichgewicht nicht zu stören.

Versand des MultiClamp 700B

Bei dem MultiClamp 700B handelt es sich um ein solide gebautes Instrument, das beim weltweiten Versand keinen Schaden nehmen sollte. Um jedoch Versandschäden zu verhindern, muß der MultiClamp 700B ordnungsgemäß verpackt werden.

Im allgemeinen läßt sich der MultiClamp 700B am besten im Originalkarton des Werks verpacken. Ist dieser nicht mehr vorhanden, empfehlen wir, den MultiClamp 700B vorsichtig in mindestens 75 mm starkem Schaumstoff oder Bubblepackungen einzuwickeln. Der so eingewickelte MultiClamp 700B sollte dann in einen festen Pappkarton gesetzt werden. Die Außenseite des Kartons ist mit dem Worten ZERBRECHLICH (FRAGILE) und einem Pfeil, der auf die Oberseite des Kartons weist, zu kennzeichnen.

Sollte der Karton vom Spediteur fallengelassen werden, besteht eine gute Möglichkeit, daß der MultiClamp 700B innerhalb der losen Schaumstoffkugerverpackung bewegt wird und dadurch beschädigt werden kann.

Wenn Sie den MultiClamp 700B an einen anderen Ort oder zurück ans Werk senden müssen und Ihnen kein angemessenes Verpackungsmaterial zur Verfügung stehen, kann Axon Instruments Ihnen das geeignete Verpackungsmaterial gegen eine kleine Gebühr zustellen. Sie mögen dies zwar als unnötige Zusatzkosten betrachten, doch ist dieser Aufwand im Vergleich zu den Reparaturkosten für ein während des Transports beschädigtes Instrument gering. Sie sind selbst für das richtige Verpacken des Instruments vor dem Versand verantwortlich. Bei einer nicht ordnungsgemäßen Verpackung, die eine Beschädigung zur Folge hat, wird der Spediteur ihren Schadensersatzanspruch nicht anerkennen.

Importante Información sobre la Seguridad

LÍMITE DE RESPONSABILIDADES

ESTE EQUIPO NO ESTÁ DISEÑADO PARA USO EN HUMANOS Y NO DEBE USARSE PARA EXPERIMENTACIÓN O APLICACIÓN EN SERES HUMANOS BAJO NINGUNA CIRCUNSTANCIA.

ADVERTENCIA

SI ESTE EQUIPO SE USA DE MANERA NO ESPECIFICADA POR EL FABRICANTE SE PODRÍA PERDER LA PROTECCIÓN PROVISTA POR EL EQUIPO.

Selección del suministro de corriente y cambio de fusibles

Voltaje de entrada

El MultiClamp 700B puede conectarse directamente a todos los suministros de energía. El límite de voltaje va entre 100 y 240 V~. No es necesario efectuar cambios en el selector. Además, el instrumento puede ser alimentado a partir de una fuente de corriente continua con voltajes entre 120 y 310 V.

Cambio de fusible

El MultiClamp 700B utiliza un fusible de 250 V~, T2A, 5 × 20 mm.

En el caso de que un fusible falle, desconecte el cordón eléctrico.

Antes de cambiar el fusible investigue la causa de la falla.

Para cambiar el fusible:

1. Desconecte el cordón eléctrico.
2. Use un destornillador o un dispositivo similar para girar el portafusibles en sentido contrario al de las manecillas del reloj.
3. Reemplace el fusible existente con otro de la misma capacidad.
4. Conecte nuevamente el cordón eléctrico.

Instalación básica y seguridad del equipo

1. Suministro de corriente y conexión a tierra: Use el cordón eléctrico IEC incluido para conectar el instrumento a una toma de corriente CON CONEXIÓN A TIERRA.
2. Montaje: Sobre una mesa o en un estante.
3. Ensamblaje: El cabezal ("headstage") se conecta al instrumento en el tablero posterior con el conector de 25 clavijas D-sub, marcado "Headstage".
4. Uso: No utilice este equipo sin las cubiertas o paneles.
5. Limpieza: Limpie el conector del "headstage" con un paño húmedo a fin de quitar los derrames de sales. Evite derramar líquidos sobre el "headstage".
El conector de entrada fabricado de Teflon debe mantenerse muy limpio. Puede hacerse una limpieza efectiva rociando con alcohol o con un algodón humedecido con agua desionizada. En la medida de lo posible evite el uso del gas freón, puesto que es dañino para el medio ambiente.

Condiciones de seguridad ambiental

1. Para uso interior.
2. Fluctuaciones eléctricas en la fuente de suministro: no deben exceder $\pm 10\%$ del voltaje nominal.
3. Temperatura: entre 5 °C y 40 °C.
4. Altitud: hasta 2.000 m
5. Este instrumento está diseñado para ser usado en condiciones de laboratorio. Debe operarse únicamente en un ambiente limpio y seco. No lo use en un ambiente húmedo ni mojado.

Precauciones contra la estática

El "headstage" puede manejarse con seguridad, bajo condiciones normales. Sin embargo, si usted se encuentra en un laboratorio donde la estática es alta (por ejemplo, si escucha y percibe chispas cuando toca los objetos), usted debería tocar inmediatamente un objeto metálico que esté en contacto con tierra, antes de tocar el "headstage".

No apague el interruptor principal del MultiClamp 700B cuando manipule la entrada del "headstage" ya que esto afectará el equilibrio térmico.

Envío del MultiClamp 700B

El MultiClamp 700B es un instrumento de construcción sólida, diseñado para soportar el transporte a cualquier parte del mundo. Sin embargo, para evitar los daños que pudieran ocurrir durante su envío, el MultiClamp 700B debe empacarse adecuadamente.

En general, la mejor manera de empacar el MultiClamp 700B es en la caja original de fábrica. Si ésta ya no se encuentra disponible, le recomendamos que envuelva cuidadosamente el MultiClamp 700B en una funda o sábana de espuma o de "empaquete de burbujas" con un espesor mínimo de 3 pulgadas (75 mm). El MultiClamp 700B, envuelto así, deberá colocarse en una caja de cartón resistente. Marque el exterior de la caja con la palabra FRÁGIL y una flecha que indique la posición hacia arriba.

No recomendamos el uso de bolitas de espuma sueltas para proteger el MultiClamp 700B. Si la caja se cae accidentalmente durante el transporte, es muy probable que el MultiClamp 700B se desplace dentro del contenedor con las bolitas de espuma sueltas y se dañe.

Si necesita enviar su MultiClamp 700B a otra localidad, o de regreso a la fábrica, y no posee el empaque adecuado, Axon Instruments puede enviarse el material necesario por un cargo mínimo. Esto podría parecerle un gasto superfluo que preferiría evitar, pero es económico comparado con lo que costaría la reparación de un instrumento que ha sufrido daños durante el envío.

Es su responsabilidad empacar el instrumento adecuadamente antes de enviarlo. Si no lo hace así y resulta dañado, el transportista no será responsable ni aceptará su reclamo de indemnización.

Index

- Audio Monitor, 68, 69, 70, 71, 145
- Auto
 - Bridge Balance, 32, 33, 65, 75, 76, 77, 84, 86, 117, 124
 - Leak Subtraction, 28, 29, 51, 54, 110, 111, 117
 - Output Zero, 29, 33, 111, 117
 - Whole Cell, 130, 142
- Bandwidth, Rs Compensation, 128, 129, 134
- BATH HEADSTAGE, 45, 72, 74
 - VG, 74
- Bridge Balance, 32, 33, 65, 75, 76, 77, 84, 86, 117, 124
- Buzz, 65, 78, 87, 143
- Calibration, 11
- Capacitance Compensation
 - Current Clamp, 6, 19, 31, 90, 101, 142
 - Electrode, 17, 19, 45, 58, 60, 61, 78, 79, 105, 115, 116
 - Fast, 7, 12, 13, 24, 25, 28, 29, 51, 53, 80, 83, 126, 128, 133, 135, 142
 - Slow, 24, 25, 51, 80, 83, 126, 142
 - Whole-cell, 51, 81, 130, 142
 - Whole-Cell, 12
- Capacitance Neutralization, 33, 62, 65, 75, 77, 84, 86, 116, 124, 140
- Cleaning
 - Headstage, 47, 58, 72, 91, 93, 98, 101, 102, 111, 114, 115, 122, 141
 - Holders, 58, 103
- Clear, 65, 78, 87, 143
- Correction, 30, 127, 128, 129, 134, 135
- Current Clamp
 - Capacitance Compensation, 78, 79, 80, 83, 89, 90, 110, 118, 122, 124, 126
 - Model Cell, 112, 125
 - Whole-cell, 51, 81
- Electrochemistry, 87
- External Command, 78, 84, 89, 90, 91, 93, 97, 107
- External Command Inputs, 78, 84, 89, 91, 93, 97, 107
- Filter, 89, 90, 95, 97, 128, 142, 144
- Functional Checkout, 6
- Gain, 23, 24, 110, 118, 141, 144
- Glass
 - Dimensions, 141
 - Types, 95
- Grounding, 97, 114, 116, 120
- Headstage
 - Adapters, 107
 - Cleaning, 102, 107, 159
 - Gain, 23, 110, 118, 141, 144
 - Mounting, 102, 159
- Help
 - On-line, 67, 103
- Holder, Pipette
 - Cleaning, 102, 107
 - Use, 74, 83, 84, 86, 105, 107, 121, 159, 162
- Holding, 7, 27, 29, 31, 37, 51, 63, 65, 90, 143
- Hum, 97, 114, 116, 120
- Input/Output Connections, 107, 111, 117
- Installation, 3, 122, 160, 161
- Lag, 128
- Leak Subtraction, 28, 29, 51, 54, 110, 111, 117
- Mode, 6, 31, 89, 91, 93, 98, 107, 108, 111, 112, 122

- Automatic Switch, 37
- I=0, 6, 37, 45, 59, 111, 112
- I-Clamp, 20, 31, 46, 47, 59, 64, 75, 78, 84, 87, 90, 91, 93, 97, 98, 101, 108, 109, 111, 112, 115, 116, 117, 124, 140
- V-Clamp, 7, 17, 46, 47, 59, 78, 89, 90, 91, 96, 97, 98, 99, 108, 109, 110, 111, 114, 115, 116, 117, 122, 123, 124, 138
- Model Cell, 16, 112, 125
- MultiClamp 700B Commander, 3, 4, 5, 6, 7, 9, 10, 11, 12, 13
- Noise, 11, 47, 91, 92, 93, 97, 98, 101, 114, 116, 141, 142
- Options, 10, 12, 21, 24, 51, 83, 89, 90, 91, 93, 97, 107
- Oscillations, 135
 - Reduce Compensation, 33, 34
- Oscilloscope Triggering, 107, 116
- Output
 - Filter, 89, 90, 95, 97, 128, 142, 144
 - Gain, 23, 110, 118, 141, 144
- Overload, 91, 118
- Pipette, 16, 18, 49, 56, 62, 63, 64, 65, 77, 86, 116, 140, 143
 - Chloriding, 106
 - Cleaning, 102, 107
 - Filling, 64, 106
 - Glass, 56, 61
 - Insertion, 105
- Pipette Offset, 18, 20, 49, 63, 64, 140, 143
- Polarity Conventions, 67, 118, 119
- Power Supply
 - Glitches, 121
 - Voltage Selection, 121, 159
- Practical Guide
 - Forming a Gigaseal, 49
 - Interfacing a Computer, 46
 - Low Noise Techniques, 48, 55
 - Perforated-patch Recording, 54
 - Sharp Microelectrode Recording, 47, 59, 85, 86, 115
 - Whole-cell Voltage Clamp Recording, 51
- Prediction, 30, 127, 128, 129, 131, 132, 133, 134, 135
- Primary Output, 17, 18, 19, 20, 21, 22, 23, 24, 26, 27, 28, 29, 30, 31, 32, 33, 37, 49, 64, 65, 76, 86, 93, 96, 97, 110, 117, 128, 140, 144
- Pulse, 30, 37, 89, 90, 109, 117, 143
- Quick Select, 9, 10
- Reset to Program Defaults, 17, 26
- Seal Test, 8, 12, 18, 19, 24, 26, 27, 29, 49, 90, 96, 109, 117, 125, 138, 143
- Secondary Output, 144
- Select Device, 122, 139
- Series Resistance
 - Compensation, 30, 54, 78, 82, 98, 100, 114, 116, 122, 124, 125, 128, 129, 131, 133, 134, 135, 136
 - Correction, 30, 127, 128, 129, 134, 135
 - Fast, 7, 25, 29, 51, 53, 80, 83, 126, 128, 133, 135, 142
 - Lag, 128
 - Oscillations, 135
 - Prediction, 30, 127, 128, 129, 131, 132, 133, 134, 135
 - Slow, 51, 80, 83, 126, 142
- Status, 138, 139
- Tutorials
 - Giga Seal Configuration, 21
- VG-2, 72
- Zap, 52, 138, 143